

NEW OPTION ADDED

High performance metal disc coupling

SERVOFLEX SFC



High-stiffness and low-inertia couplings

Metal disc couplings developed for high-speed, high-precision positioning, and ultra-precise control of servomotors, etc. While achieving high torsional stiffness, high torque, low inertia, and high response speed, these couplings are also flexible in the parallel misalignment direction, in the angular directions, and in the axial direction.

This model has a single element type that emphasizes stiffness and a double element type that emphasizes flexibility. A wide variety of options such as a tapered shaft, length-specified special order, and keyway milling application are available.



High-rigidity metal disc flexible couplings

A layered metal disc is rigid in the torsional direction and flexible in the parallel misalignment, angular, and axial direction.

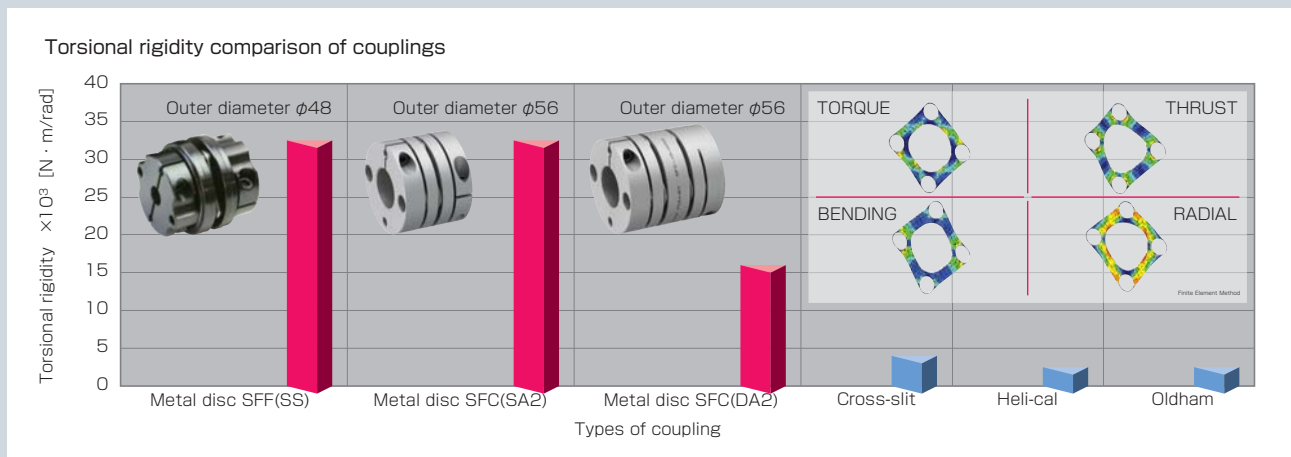

No backlash

No backlash, accurate shaft rotation, and precise control.

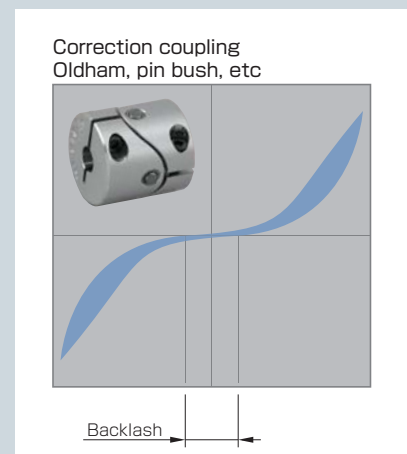
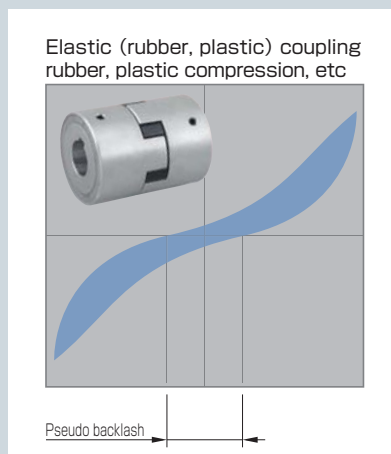
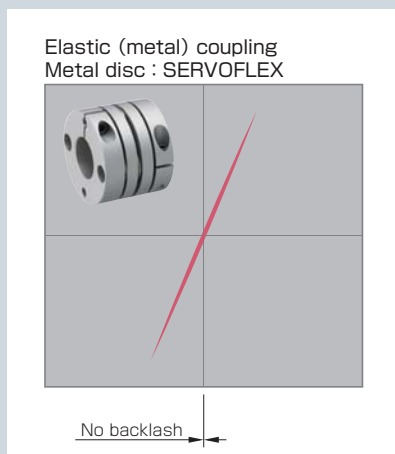

Heat rejection

The stainless-steel plate spring reduces thermal conduction from a servo motor to the driven shaft, which also reduces variations in accuracy caused by thermal expansion.

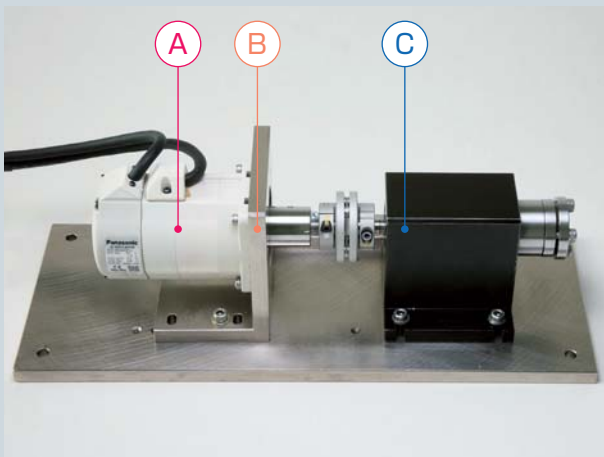

Each portion temperature transition

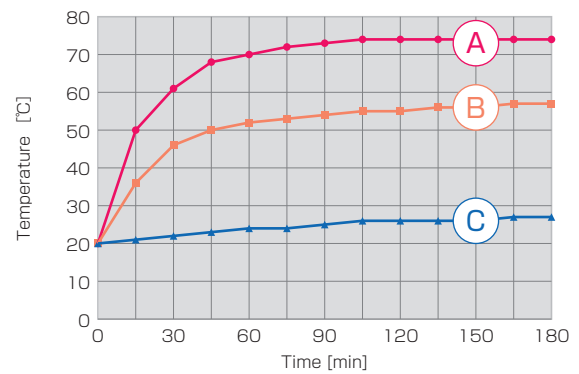

Various options to choose from

Various options are available on a single-element and double-element basis.

Standard specifications

Clamp hub
Material: High-strength aluminum alloy
Surface finishing: Alumite treatment

Clamp bolt
Material: Alloy steel for machine structural use
Surface finishing: Solid lubricant coating
* Size 002 is black oxide finishing.

Element
material metal disc: SUS304
collar: SUS304
* The collar material of size 080,090,100 are S45C and surface finishing is trivalent chrome treatment.

Bolt
Material: Alloy steel for machine structural use
Surface finishing: trivalent chrome treatment
* Size 080,090,100 are anti-rust coating.

Spacer
Material: High-strength aluminum alloy
Surface finishing: Alumite treatment

Option

- Compatible with shaft tolerance j6/k6
Corresponds to shaft tolerances j6 and k6 for the standard specification h7.
- Tapered shaft supported
Allows coupling via a clamp hub when a taper adapter is mounted on the tapered shaft of a servo motor.
- For length-specified special order parts
SFC (DA2) type spacer length can be changed to attain the necessary distance between shafts. Specify the length in 1 mm units.
- For keyway milling applications
If you are using a keyed shaft, we can mill a keyway in the clamping hub to your specifications.

Clean room compatible

Clamp hub
Material: High-strength aluminum alloy
Surface finishing: Non

Clamp bolt
Material: SUS304
Surface finishing: Non

Bolt
Material: SUS304
Surface finishing: Non

NEW

* Clean bench ISO class 6 assembly

Element
material metal disc: SUS304
collar: SUS304

Spacer
Material: High-strength aluminum alloy
Surface finishing: Non

*These measurement results were calculated from actual experiments performed using MIKI PULLEY procedures and are not to be interpreted as guarantees of product performance.

Single Element Type

Specifications

Model	Shape type	Rated torque [N·m]	Misalignment			Max. rotation speed [min ⁻¹]	Torsional stiffness [N·m/rad]	Axial stiffness [N/mm]	Moment of inertia [kg·m ²]	Mass [kg]
			Parallel [mm]	Angular [°]	Axial [mm]					
SFC-002SA2	C	0.25	0.01	0.5	±0.04	10000	190	34	0.06×10 ⁻⁶	0.003
SFC-005SA2	C	0.6	0.02	0.5	±0.05	10000	500	140	0.26×10 ⁻⁶	0.007
SFC-010SA2	C	1	0.02	1	±0.1	10000	1400	140	0.58×10 ⁻⁶	0.011
SFC-020SA2	C	2	0.02	1	±0.15	10000	3700	64	2.39×10 ⁻⁶	0.025
SFC-025SA2	C	4	0.02	1	±0.19	10000	5600	60	3.67×10 ⁻⁶	0.029
SFC-030SA2	A	5	0.02	1	±0.2	10000	8000	64	4.07×10 ⁻⁶	0.034
	B	5	0.02	1	±0.2	10000	8000	64	6.09×10 ⁻⁶	0.041
	C	5	0.02	1	±0.2	10000	8000	64	8.20×10 ⁻⁶	0.049
SFC-035SA2	C	10	0.02	1	±0.25	10000	18000	112	18.44×10 ⁻⁶	0.082
SFC-040SA2	A	12	0.02	1	±0.3	10000	20000	80	16.71×10 ⁻⁶	0.077
	B	12	0.02	1	±0.3	10000	20000	80	22.55×10 ⁻⁶	0.085
	C	12	0.02	1	±0.3	10000	20000	80	29.25×10 ⁻⁶	0.100
SFC-050SA2	A	25	0.02	1	±0.4	10000	32000	48	55.71×10 ⁻⁶	0.159
	B	25	0.02	1	±0.4	10000	32000	48	76.26×10 ⁻⁶	0.177
	C	25	0.02	1	±0.4	10000	32000	48	99.03×10 ⁻⁶	0.206
SFC-055SA2	C	40	0.02	1	±0.42	10000	50000	43	188.0×10 ⁻⁶	0.314
SFC-060SA2	A	60	0.02	1	±0.45	10000	70000	76.4	145.9×10 ⁻⁶	0.283
	B	60	0.02	1	±0.45	10000	70000	76.4	205.0×10 ⁻⁶	0.326
	C	60	0.02	1	±0.45	10000	70000	76.4	268.6×10 ⁻⁶	0.385
SFC-080SA2	C	100	0.02	1	±0.55	10000	140000	128	710.6×10 ⁻⁶	0.708
SFC-090SA2	C	180	0.02	1	±0.65	10000	100000	108	1236×10 ⁻⁶	0.946
SFC-100SA2	C	250	0.02	1	±0.74	10000	120000	111	1891×10 ⁻⁶	1.202

* Types A / B / C are automatically specified by Miki Pulley according to the combination of bore diameters you select, and cannot be specified by the customer. * Check the Standard Bore Diameter list as rated torque may be restricted by the holding power of the shaft connection component. * Max. rotation speed does not take into account dynamic balance. * Torsional stiffness values given are measured values for the element alone. * The moment of inertia and mass are measured for the maximum bore diameter.

Dimensions

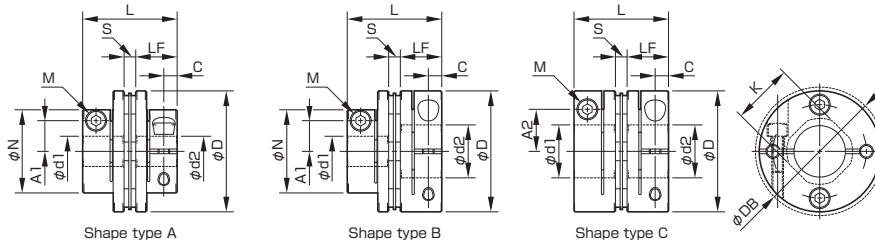

Model	Shape type	d1 [mm]		d2 [mm]		D [mm]	DB [mm]	N [mm]	L [mm]	LF [mm]	S [mm]	A1 [mm]	A2 [mm]	C [mm]	K [mm]	M Quantity - Nominal dia.	Tightening torque [N·m]
		Min.	Max.	Min.	Max.												
SFC-002SA2	C	3	5	3	5	12	12.4	-	12.35	5.9	0.55	-	3.7	1.9	5.6	1-M1.6	0.23 ~ 0.28
SFC-005SA2	C	3	6	3	6	16	-	-	16.7	7.85	1	-	4.8	2.5	6.5	1-M2	0.4 ~ 0.5
SFC-010SA2	C	3	8	3	8	19	-	-	19.35	9.15	1.05	-	5.8(6)	3.15	8.5	1-M2.5(M2)	1.0 ~ 1.1(0.4 ~ 0.5)
SFC-020SA2	C	4	10	4	11	26	-	-	23.15	10.75	1.65	-	9.5	3.3	10.6	1-M2.5	1.0 ~ 1.1
SFC-025SA2	C	5	14	5	14	29	-	-	23.4	10.75	1.9	-	11	3.3	14.5	1-M2.5	1.0 ~ 1.1
	A	5	10	5	10	34	-	21.6	27.3	12.4	2.5	8	-	3.75	14.5	1-M3	1.5 ~ 1.9
SFC-030SA2	B	5	10	Over10	16	34	-	21.6	27.3	12.4	2.5	8	12.5	3.75	14.5	1-M3	1.5 ~ 1.9
	C	Over10	14	Over10	16	34	-	-	27.3	12.4	2.5	-	12.5	3.75	14.5	1-M3	1.5 ~ 1.9
SFC-035SA2	C	6	16	6	19	39	-	-	34	15.5	3	-	14	4.5	17	1-M4	3.4 ~ 4.1
SFC-040SA2	A	8	15	8	15	44	-	29.6	34	15.5	3	11	-	4.5	19.5	1-M4	3.4 ~ 4.1
	B	8	15	Over15	24	44	-	29.6	34	15.5	3	11	17	4.5	19.5	1-M4	3.4 ~ 4.1
	C	Over15	19	Over15	24	44	-	-	34	15.5	3	-	17	4.5	19.5	1-M4	3.4 ~ 4.1
SFC-050SA2	A	8	19	8	19	56	-	38	43.4	20.5	2.4	14.5	-	6	26	1-M5	7.0 ~ 8.5
	B	8	19	Over19	30	56	-	38	43.4	20.5	2.4	14.5	22	6	26	1-M5	7.0 ~ 8.5
	C	Over19	25	Over19	30	56	-	-	43.4	20.5	2.4	-	22	6	26	1-M5	7.0 ~ 8.5
SFC-055SA2	C	10	30	10	30	63	-	-	50.6	24	2.6	-	23	7.75	31	1-M6	14 ~ 15
	A	11	24	11	24	68	-	46	53.6	25.2	3.2	17.5	-	7.75	31	1-M6	14 ~ 15
	B	11	24	Over24	35	68	-	46	53.6	25.2	3.2	17.5	26.5	7.75	31	1-M6	14 ~ 15
SFC-060SA2	C	Over24	30	Over24	35	68	-	-	53.6	25.2	3.2	-	26.5	7.75	31	1-M6	14 ~ 15
	A	18	35	18	40	82	-	-	68	30	8	-	28	9	38	1-M8	27 ~ 30
SFC-090SA2	C	25	40	25	45	94	-	-	68.3	30	8.3	-	34	9	42	1-M8	27 ~ 30
SFC-100SA2	C	32	45	32	45	104	-	-	69.8	30	9.8	-	39	9	48	1-M8	27 ~ 30

* Types A / B / C are automatically specified by Miki Pulley according to the combination of bore diameters you select, and cannot be specified by the customer. * The øDB value is measured assuming that the head of the clamping bolt is larger than the external diameter of the hub. * The K dimension is the inner diameter of the element. For d2 dimension exceeding this value, shaft can be inserted only up to LF dimension to the d2 side hub. * The nominal diameter for the clamping bolt M is equal to the quantity minus the nominal diameter of the screw threads, where the quantity is for a hub on one side. * The figures in parentheses () for the SFC-010 are the values when d1 or d2 is ø8 mm.



Standard bore diameters

		Standard (option) bore diameter, d1/d2 [mm] and restricted rated torque [N·m]																															
Nominal bore diameter		3	4	5	6	6.35	7	8	9	9.525	10	11	12	13	14	15	16	17	18	19	20	22	24	25	28	30	32	35	38	40	42	45	
Shaft tolerance	h7 (h6,g6)	B	●	●	●	●	●	●	●	●	●	●	●	●	●	●	●	●	●	●	●	●	●	●	●	●	●	●	●	●	●	●	●
	j6 (Option)	J																			○	○	○	○	○								
	k6 (Option)	K						○	○						○	○				○	○	○					○	○					
Supported bore diameter for each model	SFC-002SA2	d1	●	●	●																												
	d2	●	●	●																													
	SFC-005SA2	d1	●	●	●	●																											
	d2	●	●	●	●																												
	SFC-010SA2	d1	●	●	●	●	●	●																									
	d2	●	●	●	●	●	●	●																									
	SFC-020SA2	d1		●	●	●	●	●	●	●																							
	d2		●	●	●	●	●	●	●	●																							
	SFC-025SA2	d1			2.1	●	●	●	●	●	●	●	●	●	●	●																	
	d2			2.1	●	●	●	●	●	●	●	●	●	●	●	●																	
	SFC-030SA2	d1			2.8	3.4	●	●	●	●	●	●	●	●	●	●	●																
	d2			2.8	3.4	●	●	●	●	●	●	●	●	●	●	●	●																
	SFC-035SA2	d1				5	5	6.6	●	●	●	●	●	●	●	●	●	●															
	d2					5	5	6.6	●	●	●	●	●	●	●	●	●	●															
	SFC-040SA2	d1							9	●	●	●	●	●	●	●	●	●	●	●	●	●	●	●	●	●	●	●	●	●	●	●	●
	d2								9	●	●	●	●	●	●	●	●	●	●	●	●	●	●	●	●	●	●	●	●	●	●	●	●
	SFC-050SA2	d1								18	20	22	22	●	●	●	●	●	●	●	●	●	●	●	●	●	●	●	●	●	●	●	●
	d2									18	20	22	22	●	●	●	●	●	●	●	●	●	●	●	●	●	●	●	●	●	●	●	●
	SFC-055SA2	d1											31	34	36	38	●	●	●	●	●	●	●	●	●	●	●	●	●	●	●	●	
	d2												31	34	36	38	●	●	●	●	●	●	●	●	●	●	●	●	●	●	●	●	
SFC-060SA2	d1												50	51	●	●	●	●	●	●	●	●	●	●	●	●	●	●	●	●	●		
d2													50	51	●	●	●	●	●	●	●	●	●	●	●	●	●	●	●	●	●		
SFC-080SA2	d1																																
d2																																	
SFC-090SA2	d1																																
d2																																	
SFC-100SA2	d1																																
d2																																	

* The shaft tolerance for standard bore diameter is h7 (h6 or g6): designation B. However, for a bore diameter of ø35, the shaft tolerance is $^{+0.010}_{-0.005}$. * Shaft tolerances j6/k6: designations J/K are optional, and are only supported for bore diameters marked with ○. * Bore diameters marked with ● or numbers are supported as the standard bore diameters. Consult Miki Pulley regarding special arrangements which may be possible for other bore diameters. * Bore diameters whose fields contain numbers are restricted in their rated torque by the holding power of the shaft connection component because the bore diameter is small. The numbers indicate the rated torque [N·m].

How to Place an Order

SFC-025SA2-10B-14K

Size ————
 Type ————
 SA2: Single element
 Bore diameter d1 (Small diameter) ————
 Bore diameter d2 (Large diameter) ————

Supported shaft tolerance
 B: h7(h6,g6) shaft
 J: j6 shaft (Option)
 K: k6 shaft (Option)

* For nominal bore diameter, select d1 (small diameter)-d2 (large diameter) in that order.

* If d1=d2 (same diameters), select B, J, and K in that order.

Double Element Type

Specifications

Model	Shape type	Rated torque [N·m]	Misalignment			Max. rotation speed [min ⁻¹]	Torsional stiffness [N·m/rad]	Axial stiffness [N/mm]	Moment of inertia [kg·m ²]	Mass [kg]
			Parallel [mm]	Angular [°]	Axial [mm]					
SFC-002DA2	C	0.25	0.03	0.5(On one side)	±0.08	10000	95	17	0.07×10 ⁻⁶	0.004
SFC-005DA2	C	0.6	0.05	0.5(On one side)	±0.1	10000	250	70	0.37×10 ⁻⁶	0.010
SFC-010DA2	C	1	0.11	1(On one side)	±0.2	10000	700	70	0.80×10 ⁻⁶	0.015
SFC-020DA2	C	2	0.15	1(On one side)	±0.33	10000	1850	32	3.43×10 ⁻⁶	0.035
SFC-025DA2	C	4	0.16	1(On one side)	±0.38	10000	2800	30	5.26×10 ⁻⁶	0.040
SFC-030DA2	A	5	0.18	1(On one side)	±0.4	10000	4000	32	7.43×10 ⁻⁶	0.054
	B	5	0.18	1(On one side)	±0.4	10000	4000	32	9.45×10 ⁻⁶	0.060
SFC-035DA2	C	5	0.18	1(On one side)	±0.4	10000	4000	32	11.56×10 ⁻⁶	0.068
	C	10	0.24	1(On one side)	±0.5	10000	9000	56	26.93×10 ⁻⁶	0.121
SFC-040DA2	A	12	0.24	1(On one side)	±0.6	10000	10000	40	29.98×10 ⁻⁶	0.124
	B	12	0.24	1(On one side)	±0.6	10000	10000	40	35.82×10 ⁻⁶	0.131
	C	12	0.24	1(On one side)	±0.6	10000	10000	40	42.52×10 ⁻⁶	0.146
SFC-050DA2	A	25	0.28	1(On one side)	±0.8	10000	16000	24	98.34×10 ⁻⁶	0.250
	B	25	0.28	1(On one side)	±0.8	10000	16000	24	118.9×10 ⁻⁶	0.268
	C	25	0.28	1(On one side)	±0.8	10000	16000	24	141.7×10 ⁻⁶	0.298
SFC-055DA2	C	40	0.31	1(On one side)	±0.84	10000	25000	21.5	261.3×10 ⁻⁶	0.459
SFC-060DA2	A	60	0.34	1(On one side)	±0.9	10000	35000	38.2	256.6×10 ⁻⁶	0.447
	B	60	0.34	1(On one side)	±0.9	10000	35000	38.2	315.7×10 ⁻⁶	0.489
	C	60	0.34	1(On one side)	±0.9	10000	35000	38.2	379.3×10 ⁻⁶	0.549
SFC-080DA2	C	100	0.52	1(On one side)	±1.10	10000	70000	64	1039×10 ⁻⁶	1.037
SFC-090DA2	C	180	0.52	1(On one side)	±1.30	10000	50000	54	1798×10 ⁻⁶	1.369
SFC-100DA2	C	250	0.55	1(On one side)	±1.48	10000	60000	55.5	2754×10 ⁻⁶	1.739

* Types A / B / C are automatically specified by Miki Pulley according to the combination of bore diameters you select, and cannot be specified by the customer. * Check the Standard Bore Diameter list as rated torque may be restricted by the holding power of the shaft connection component. * Max. rotation speed does not take into account dynamic balance. * Torsional stiffness values given are measured values for the element alone. * The moment of inertia and mass are measured for the maximum bore diameter.

Dimensions

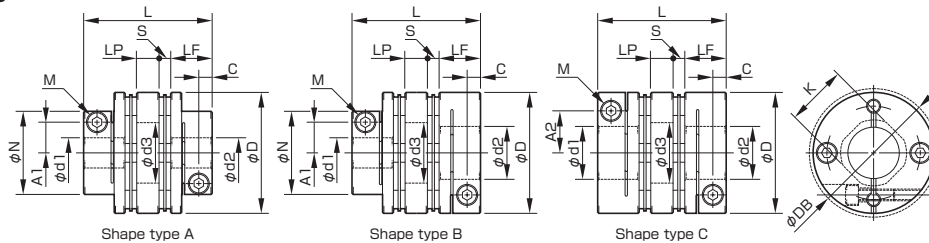

Model	Shape type	d1 [mm]		d2 [mm]		D [mm]	DB [mm]	N [mm]	L [mm]	LF [mm]	LP [mm]	S [mm]	A1 [mm]	A2 [mm]	C [mm]	d3 [mm]	K [mm]	M Quantity - Nominal dia.	Tightening torque [N·m]
		Min.	Max.	Min.	Max.														
SFC-002DA2	C	3	5	3	5	12	12.4	-	15.7	5.9	2.8	0.55	-	3.7	1.9	5.2	5.6	1-M1.6	0.23 ~ 0.28
SFC-005DA2	C	3	6	3	6	16	-	-	23.2	7.85	5.5	1	-	4.8	2.5	6.5	6.5	1-M2	0.4 ~ 0.5
SFC-010DA2	C	3	8	3	8	19	-	-	25.9	9.15	5.5	1.05	-	5.8(6)	3.15	8.5	8.5	1-M2.5(M2)	1.0 ~ 1.1(0.4 ~ 0.5)
SFC-020DA2	C	4	10	4	11	26	-	-	32.3	10.75	7.5	1.65	-	9.5	3.3	10.6	10.6	1-M2.5	1.0 ~ 1.1
SFC-025DA2	C	5	14	5	14	29	-	-	32.8	10.75	7.5	1.9	-	11	3.3	15	14.5	1-M2.5	1.0 ~ 1.1
	A	5	10	5	10	34	-	21.6	37.8	12.4	8	2.5	8	-	3.75	15	14.5	1-M3	1.5 ~ 1.9
SFC-030DA2	B	5	10	Over10	16	34	-	21.6	37.8	12.4	8	2.5	8	12.5	3.75	15	14.5	1-M3	1.5 ~ 1.9
	C	Over10	14	Over10	16	34	-	-	37.8	12.4	8	2.5	-	12.5	3.75	15	14.5	1-M3	1.5 ~ 1.9
SFC-035DA2	C	6	16	6	19	39	-	-	48	15.5	11	3	-	14	4.5	17	17	1-M4	3.4 ~ 4.1
SFC-040DA2	A	8	15	8	15	44	-	29.6	48	15.5	11	3	11	-	4.5	20	19.5	1-M4	3.4 ~ 4.1
	B	8	15	Over15	24	44	-	29.6	48	15.5	11	3	11	17	4.5	20	19.5	1-M4	3.4 ~ 4.1
	C	Over15	19	Over15	24	44	-	-	48	15.5	11	3	-	17	4.5	20	19.5	1-M4	3.4 ~ 4.1
SFC-050DA2	A	8	19	8	19	56	-	38	59.8	20.5	14	2.4	14.5	-	6	26	26	1-M5	7.0 ~ 8.5
	B	8	19	Over19	30	56	-	38	59.8	20.5	14	2.4	14.5	22	6	26	26	1-M5	7.0 ~ 8.5
	C	Over19	25	Over19	30	56	-	-	59.8	20.5	14	2.4	-	22	6	26	26	1-M5	7.0 ~ 8.5
SFC-055DA2	C	10	30	10	30	63	-	-	68.7	24	15.5	2.6	-	23	7.75	31	31	1-M6	14 ~ 15
SFC-060DA2	A	11	24	11	24	68	-	46	73.3	25.2	16.5	3.2	17.5	-	7.75	31	31	1-M6	14 ~ 15
	B	11	24	Over24	35	68	-	46	73.3	25.2	16.5	3.2	17.5	26.5	7.75	31	31	1-M6	14 ~ 15
	C	Over24	30	Over24	35	68	-	-	73.3	25.2	16.5	3.2	-	26.5	7.75	31	31	1-M6	14 ~ 15
SFC-080DA2	C	18	35	18	40	82	-	-	98	30	22	8	-	28	9	40	38	1-M8	27 ~ 30
SFC-090DA2	C	25	40	25	45	94	-	-	98.6	30	22	8.3	-	34	9	47	42	1-M8	27 ~ 30
SFC-100DA2	C	32	45	32	45	104	-	-	101.6	30	22	9.8	-	39	9	50	48	1-M8	27 ~ 30

* Types A / B / C are automatically specified by Miki Pulley according to the combination of bore diameters you select, and cannot be specified by the customer. * The øDB value is measured assuming that the head of the clamping bolt is larger than the external diameter of the hub. * The K dimension is the inner diameter of the element. For d2 dimension exceeding this value, shaft can be inserted only up to LF dimension to the d2 side hub. * The nominal diameter for the clamping bolt M is equal to the quantity minus the nominal diameter of the screw threads, where the quantity is for a hub on one side. * The figures in parentheses () for the SFC-010 are the values when d1 or d2 is ø8 mm.



Standard bore diameters

		Standard (option) bore diameter, d1/d2 [mm] and restricted rated torque [N·m]																																
Nominal bore diameter		3	4	5	6	6.35	7	8	9	9.525	10	11	12	13	14	15	16	17	18	19	20	22	24	25	28	30	32	35	38	40	42	45		
Shaft tolerance	h7 (h6,g6)	B	●	●	●	●	●	●	●	●	●	●	●	●	●	●	●	●	●	●	●	●	●	●	●	●	●	●	●	●	●	●	●	
	j6 (Option)	J																			○	○	○		○									
	k6 (Option)	K						○	○						○	○		○	○	○	○	○					○	○						
Supported bore diameter for each model	SFC-002DA2	d1	●	●	●																													
	d2	●	●	●																														
	SFC-005DA2	d1	●	●	●	●																												
	d2	●	●	●	●																													
	SFC-010DA2	d1	●	●	●	●	●	●																										
	d2	●	●	●	●	●	●	●																										
	SFC-020DA2	d1		●	●	●	●	●	●	●																								
	d2		●	●	●	●	●	●	●	●																								
	SFC-025DA2	d1			2.1	●	●	●	●	●	●	●	●	●	●	●																		
	d2			2.1	●	●	●	●	●	●	●	●	●	●	●	●																		
	SFC-030DA2	d1			2.8	3.4	●	●	●	●	●	●	●	●	●	●	●																	
	d2			2.8	3.4	●	●	●	●	●	●	●	●	●	●	●	●	●																
	SFC-035DA2	d1				5	5	6.6	●	●	●	●	●	●	●	●	●	●	●															
	d2					5	5	6.6	●	●	●	●	●	●	●	●	●	●	●	●	●													
	SFC-040DA2	d1							9	●	●	●	●	●	●	●	●	●	●	●	●													
	d2								9	●	●	●	●	●	●	●	●	●	●	●	●	●	●											
	SFC-050DA2	d1								18	20	22	22	●	●	●	●	●	●	●	●	●	●	●	●	●	●	●	●	●	●	●	●	
	d2									18	20	22	22	●	●	●	●	●	●	●	●	●	●	●	●	●	●	●	●	●	●	●	●	
	SFC-055DA2	d1											31	34	36	38	●	●	●	●	●	●	●	●	●	●	●	●	●	●	●	●	●	
	d2												31	34	36	38	●	●	●	●	●	●	●	●	●	●	●	●	●	●	●	●	●	
SFC-060DA2	d1												50	51	●	●	●	●	●	●	●	●	●	●	●	●	●	●	●	●	●			
d2													50	51	●	●	●	●	●	●	●	●	●	●	●	●	●	●	●	●	●			
SFC-080DA2	d1																																	
d2																																		
SFC-090DA2	d1																																	
d2																																		
SFC-100DA2	d1																																	
d2																																		

* The shaft tolerance for standard bore diameter is h7 (h6 or g6): designation B. However, for a bore diameter of ø35, the shaft tolerance is $^{+0.010}_{-0.005}$. * Shaft tolerances j6/k6: designations J/K are optional, and are only supported for bore diameters marked with ○. * Bore diameters marked with ● or numbers are supported as the standard bore diameters. Consult Miki Pulley regarding special arrangements which may be possible for other bore diameters. * Bore diameters whose fields contain numbers are restricted in their rated torque by the holding power of the shaft connection component because the bore diameter is small. The numbers indicate the rated torque [N·m].

How to Place an Order

SFC-025DA2-10B-14B

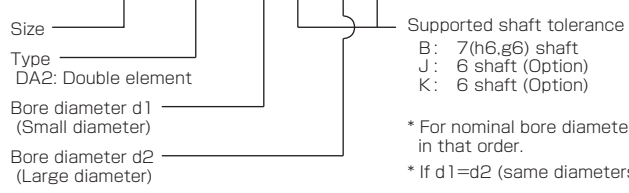

* For nominal bore diameter, select d1 (small diameter)-d2 (large diameter) in that order.
* If d1=d2 (same diameters), select B, J, and K in that order.

Option Tapered shaft supported

Allows coupling via a clamp hub when a taper adapter is mounted on the tapered shaft of a servo motor.

Specifications

Model	Shape type	Rated torque [N·m]	Misalignment			Max. rotation speed [min ⁻¹]	Torsional stiffness [N·m/rad]	Axial stiffness [N/mm]	Moment of inertia [kg·m ²]	Mass [kg]
			Parallel [mm]	Angular [°]	Axial [mm]					
SFC-040SA2-□B-11BC	B	12	0.02	1	±0.3	10000	20000	80	26.58 × 10 ⁻⁶	0.131
	C	12	0.02	1	±0.3	10000	20000	80	33.28 × 10 ⁻⁶	0.146
SFC-050SA2-□B-11BC	B	25	0.02	1	±0.4	10000	32000	48	82.91 × 10 ⁻⁶	0.240
	C	25	0.02	1	±0.4	10000	32000	48	103.5 × 10 ⁻⁶	0.258
SFC-050SA2-□B-14BC	B	25	0.02	1	±0.4	10000	32000	48	88.72 × 10 ⁻⁶	0.271
	C	25	0.02	1	±0.4	10000	32000	48	111.5 × 10 ⁻⁶	0.301
SFC-050SA2-□B-16BC	B	25	0.02	1	±0.4	10000	32000	48	95.44 × 10 ⁻⁶	0.309
	C	25	0.02	1	±0.4	10000	32000	48	118.2 × 10 ⁻⁶	0.338
SFC-055SA2-□B-14BC	C	40	0.02	1	±0.42	10000	50000	43	201.1 × 10 ⁻⁶	0.409
SFC-055SA2-□B-16BC	C	40	0.02	1	±0.42	10000	50000	43	207.8 × 10 ⁻⁶	0.446
SFC-060SA2-□B-16BC	B	60	0.02	1	±0.45	10000	70000	76.4	228.7 × 10 ⁻⁶	0.475
	C	60	0.02	1	±0.45	10000	70000	76.4	287.8 × 10 ⁻⁶	0.517

* Types B / C are automatically specified by Miki Pulley according to the bore diameter you select, and cannot be specified by the customer. * Check the "Standard Bore Diameters" as rated torque may be restricted by the holding power of the shaft connection component. * Max. rotation speed does not take into account dynamic balance. * Torsional stiffness values given are measured values for the element alone. * The moment of inertia and mass are measured for the maximum bore diameter.

Dimensions

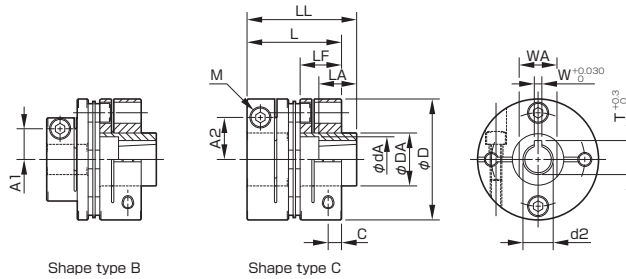

Model	d2 [mm]	W [mm]	T [mm]	WA [mm]	LA [mm]	dA [mm]	DA [mm]	LL [mm]	D [mm]	L [mm]	LF [mm]	C [mm]	A1 [mm]	A2 [mm]	M Quantity - Nominal dia.
SFC-040SA2-□B-11BC	11	4	12.2	18	16	17	22	44	44	34	15.5	4.5	11	17	1-M4
SFC-050SA2-□B-11BC	11	4	12.2	18	16	17	22	48.4	56	43.4	20.5	6	14.5	22	1-M5
SFC-050SA2-□B-14BC	14	4	15.1	24	19	22	28	53.4	56	43.4	20.5	6	14.5	22	1-M5
SFC-050SA2-□B-16BC	16	5	17.3	24	29	26	30	63.4	56	43.4	20.5	6	14.5	22	1-M5
SFC-055SA2-□B-14BC	14	4	15.1	24	19	22	28	56.6	63	50.6	24	7.75	-	23	1-M6
SFC-055SA2-□B-16BC	16	5	17.3	24	29	26	30	66.6	63	50.6	24	7.75	-	23	1-M6
SFC-060SA2-□B-16BC	16	5	17.3	24	29	26	30	69.6	68	53.6	25.2	7.75	17.5	26.5	1-M6

* For other dimensions, see dimensions for single element type SFC (SA2).

Standard bore diameter

Nominal bore diameter	Standard (option) bore diameter, d1 [mm] and restricted rated torque [N·m]																					
	8	9	9.525	10	11	12	13	14	15	16	17	18	19	20	22	24	25	28	30	32	35	
Shaft tolerance h7 (h6, g6) B	●	●	●	●	●	●	●	●	●	●	●	●	●	●	●	●	●	●	●	●	●	●
Shaft tolerance j6 (option) J													○	○	○	○	○	○				
Shaft tolerance k6 (option) K	○	○						○		○			○	○	○	○				○		
SFC-040SA2-□B-11BC	●	●	●	●	●	●	●	●	●	●	●	●	●	●	●	●	●	●	●	●	●	●
SFC-050SA2-□B-11BC	●	●	●	●	●	●	●	●	●	●	●	●	●	●	●	●	●	●	●	●	●	●
SFC-050SA2-□B-14BC	●	●	●	●	●	●	●	●	●	●	●	●	●	●	●	●	●	●	●	●	●	●
SFC-050SA2-□B-16BC	●	●	●	●	●	●	●	●	●	●	●	●	●	●	●	●	●	●	●	●	●	●
SFC-055SA2-□B-14BC				●	●	●	●	●	●	●	●	●	●	●	●	●	●	●	●	●	●	●
SFC-055SA2-□B-16BC				●	●	●	●	●	●	●	●	●	●	●	●	●	●	●	●	●	●	●
SFC-060SA2-□B-16BC				●	●	●	●	●	●	●	●	●	●	●	●	●	●	●	●	●	●	●

* The shaft tolerance for standard bore diameter is h7 (h6 or g6); designation B. * Shaft tolerances j6/k6; designations J/K are optional, and are only supported for bore diameters marked with ○. * Bore diameters marked with ● or numbers are supported as the standard bore diameters. Consult Miki Pulley regarding special arrangements which may be possible for other bore diameters. * Bore diameters whose fields contain numbers are restricted in their rated torque by the holding power of the shaft connection component because the bore diameter is small. The numbers indicate the rated torque [N·m].

How to Place an Order

SFC-050SA2-12B-14BC

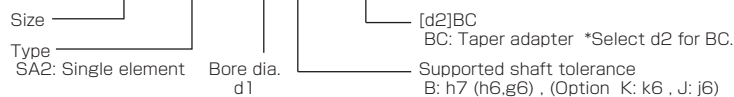



Specifications

Model	Shape type	Rated torque [N·m]	Misalignment			Max. rotation speed [min ⁻¹]	Torsional stiffness [N·m/rad]	Axial stiffness [N/mm]	Moment of inertia [kg·m ²]	Mass [kg]
			Parallel [mm]	Angular [°]	Axial [mm]					
SFC-040DA2-□B-11BC	B	12	0.24	1 (On one side)	±0.6	10000	10000	40	39.42 × 10 ⁻⁶	0.180
	C	12	0.24	1 (On one side)	±0.6	10000	10000	40	46.12 × 10 ⁻⁶	0.195
SFC-050DA2-□B-11BC	B	25	0.28	1 (On one side)	±0.8	10000	16000	24	125.5 × 10 ⁻⁶	0.331
	C	25	0.28	1 (On one side)	±0.8	10000	16000	24	146.1 × 10 ⁻⁶	0.349
SFC-050DA2-□B-14BC	B	25	0.28	1 (On one side)	±0.8	10000	16000	24	131.1 × 10 ⁻⁶	0.362
	C	25	0.28	1 (On one side)	±0.8	10000	16000	24	154.1 × 10 ⁻⁶	0.392
SFC-050DA2-□B-16BC	B	25	0.28	1 (On one side)	±0.8	10000	16000	24	138.1 × 10 ⁻⁶	0.400
	C	25	0.28	1 (On one side)	±0.8	10000	16000	24	160.8 × 10 ⁻⁶	0.430
SFC-055DA2-□B-14BC	C	40	0.31	1 (On one side)	±0.84	10000	25000	21.5	274.0 × 10 ⁻⁶	0.530
SFC-055DA2-□B-16BC	C	40	0.31	1 (On one side)	±0.84	10000	25000	21.5	280.5 × 10 ⁻⁶	0.567
SFC-060DA2-□B-16BC	B	60	0.34	1 (On one side)	±0.9	10000	35000	38.2	339.4 × 10 ⁻⁶	0.638
	C	60	0.34	1 (On one side)	±0.9	10000	35000	38.2	398.5 × 10 ⁻⁶	0.681

* Types B / C are automatically specified by Miki Pulley according to the bore diameter you select, and cannot be specified by the customer. * Check the "Standard Bore Diameters" as rated torque may be restricted by the holding power of the shaft connection component. * Max. rotation speed does not take into account dynamic balance. * Torsional stiffness values given are measured values for the element alone. * The moment of inertia and mass are measured for the maximum bore diameter.

Dimensions

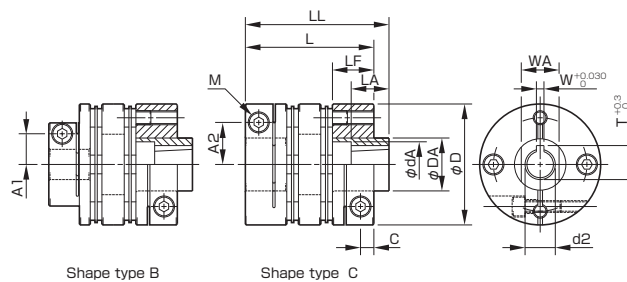

Model	d2 [mm]	W [mm]	T [mm]	WA [mm]	LA [mm]	dA [mm]	DA [mm]	LL [mm]	D [mm]	L [mm]	LF [mm]	C [mm]	A1 [mm]	A2 [mm]	M Quantity - Nominal dia.
SFC-040DA2-□B-11BC	11	4	12.2	18	16	17	22	58	44	48	15.5	4.5	11	17	1-M4
SFC-050DA2-□B-11BC	11	4	12.2	18	16	17	22	64.8	56	59.8	20.5	6	14.5	22	1-M5
SFC-050DA2-□B-14BC	14	4	15.1	24	19	22	28	69.8	56	59.8	20.5	6	14.5	22	1-M5
SFC-050DA2-□B-16BC	16	5	17.3	24	29	26	30	79.8	56	59.8	20.5	6	14.5	22	1-M5
SFC-055DA2-□B-14BC	14	4	15.1	24	19	22	28	74.4	63	68.7	24	7.75	-	23	1-M6
SFC-055DA2-□B-16BC	16	5	17.3	24	29	26	30	84.7	63	68.7	24	7.75	-	23	1-M6
SFC-060DA2-□B-16BC	16	5	17.3	24	29	26	30	89.3	68	73.3	25.2	7.75	17.5	26.5	1-M6

* For other dimensions, see dimensions for single element type SFC (DA2).

Standard bore diameter

Nominal bore diameter	Standard (option) bore diameter, d1 [mm] and restricted rated torque [N·m]																					
	8	9	9.525	10	11	12	13	14	15	16	17	18	19	20	22	24	25	28	30	32	35	
Shaft tolerance h7 (h6, g6) B	●	●	●	●	●	●	●	●	●	●	●	●	●	●	●	●	●	●	●	●	●	●
Shaft tolerance j6 (option) J													○	○	○	○	○	○				
Shaft tolerance k6 (option) K	○	○						○		○			○	○	○	○				○		
SFC-040DA2-□B-11BC	●	●	●	●	●	●	●	●	●	●	●	●	●	●	●	●	●	●	●	●	●	●
SFC-050DA2-□B-11BC					●	●	●	●	●	●	●	●	●	●	●	●	●	●	●	●	●	●
SFC-050DA2-□B-14BC					●	●	●	●	●	●	●	●	●	●	●	●	●	●	●	●	●	●
SFC-050DA2-□B-16BC					●	●	●	●	●	●	●	●	●	●	●	●	●	●	●	●	●	●
SFC-055DA2-□B-14BC																						
SFC-055DA2-□B-16BC																						
SFC-060DA2-□B-16BC																						

* The shaft tolerance for standard bore diameter is h7 (h6 or g6); designation B. * Shaft tolerances j6/k6; designations J/K are optional, and are only supported for bore diameters marked with ○. * Bore diameters marked with ● or numbers are supported as the standard bore diameters. Consult Miki Pulley regarding special arrangements which may be possible for other bore diameters. * Bore diameters whose fields contain numbers are restricted in their rated torque by the holding power of the shaft connection component because the bore diameter is small. The numbers indicate the rated torque [N·m].

How to Place an Order

SFC-050DA2-12B-14BC

Size ————
 Type ————
 DA2: Double element Bore dia. d1 ————
 [d2]BC
 BC: Taper adapter *Select d2 for BC.
 Supported shaft tolerance
 B: h7 (h6, g6), (Option K: k6, J: j6)

Option For length-specified special order parts

SFC (DA2) type spacer length can be changed to attain the necessary distance between shafts. Specify the length in 1 mm units.



Specifications

Model	Shape type	Rated torque [N·m]	Misalignment				Max. rotation speed [min ⁻¹]	Moment of inertia [kg·m ²]		Mass [kg]	
			Parallel [mm]		Angular [°]	Axial [mm]		Min. L	Max. L	Min. L	Max. L
			Min. L	Max. L							
SFC-005DA2	C	0.6	0.03	0.20	0.5(On one side)	±0.1	10000	0.33×10 ⁻⁶	0.62×10 ⁻⁶	0.009	0.017
SFC-010DA2	C	1	0.08	0.44	1(On one side)	±0.2	10000	0.72×10 ⁻⁶	1.38×10 ⁻⁶	0.014	0.026
SFC-020DA2	C	2	0.10	0.46	1(On one side)	±0.33	10000	3.02×10 ⁻⁶	5.30×10 ⁻⁶	0.031	0.054
SFC-025DA2	C	4	0.09	0.46	1(On one side)	±0.38	10000	4.55×10 ⁻⁶	7.95×10 ⁻⁶	0.036	0.061
SFC-030DA2	A	5	0.11	0.48	1(On one side)	±0.4	10000	6.09×10 ⁻⁶	12.80×10 ⁻⁶	0.046	0.085
	B	5	0.11	0.48	1(On one side)	±0.4	10000	8.11×10 ⁻⁶	14.82×10 ⁻⁶	0.053	0.091
SFC-035DA2	C	5	0.11	0.48	1(On one side)	±0.4	10000	10.22×10 ⁻⁶	16.93×10 ⁻⁶	0.061	0.099
	C	10	0.15	0.54	1(On one side)	±0.5	10000	23.85×10 ⁻⁶	35.97×10 ⁻⁶	0.108	0.161
SFC-040DA2	A	12	0.15	0.54	1(On one side)	±0.6	10000	25.06×10 ⁻⁶	44.76×10 ⁻⁶	0.107	0.174
	B	12	0.15	0.54	1(On one side)	±0.6	10000	30.89×10 ⁻⁶	50.62×10 ⁻⁶	0.116	0.182
	C	12	0.15	0.54	1(On one side)	±0.6	10000	37.58×10 ⁻⁶	57.31×10 ⁻⁶	0.130	0.197
SFC-050DA2	A	25	0.16	0.63	1(On one side)	±0.8	10000	77.42×10 ⁻⁶	144.3×10 ⁻⁶	0.205	0.347
	B	25	0.16	0.63	1(On one side)	±0.8	10000	97.97×10 ⁻⁶	164.8×10 ⁻⁶	0.225	0.365
	C	25	0.16	0.63	1(On one side)	±0.8	10000	120.8×10 ⁻⁶	187.6×10 ⁻⁶	0.252	0.394
SFC-055DA2	C	40	0.16	0.60	1(On one side)	±0.84	10000	226.8×10 ⁻⁶	325.0×10 ⁻⁶	0.378	0.538
SFC-060DA2	A	60	0.19	0.63	1(On one side)	±0.9	10000	210.8×10 ⁻⁶	340.1×10 ⁻⁶	0.382	0.567
	B	60	0.19	0.63	1(On one side)	±0.9	10000	269.9×10 ⁻⁶	399.2×10 ⁻⁶	0.424	0.609
	C	60	0.19	0.63	1(On one side)	±0.9	10000	333.5×10 ⁻⁶	462.8×10 ⁻⁶	0.484	0.669

* Types A / B / C are automatically specified by Miki Pulley according to the combination of bore diameters you select, and cannot be specified by the customer. * Check the "Standard Bore Diameters" for SFC DA2 as there may be limitations on the rated torque caused by the holding power of the coupling shaft section. * Max. rotation speed does not take into account dynamic balance. * The moment of inertia and mass are measured for the maximum bore diameter. * See "Specifications" for SFC DA2 for stiffness values.

Dimensions

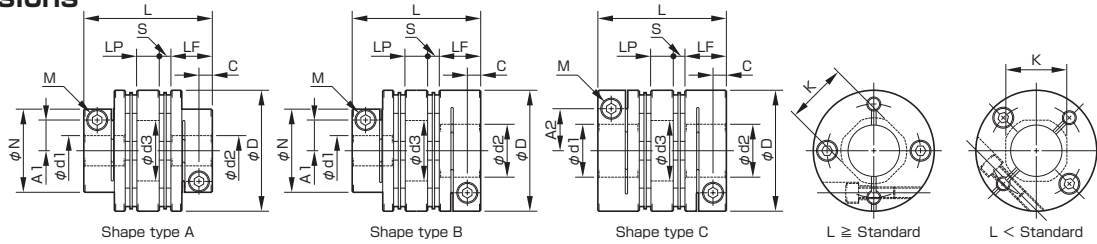

Model	Shape type	d1 [mm]		d2 [mm]		D [mm]	N [mm]	L [mm]			LF [mm]	S [mm]	A1 [mm]	A2 [mm]	C [mm]	d3 [mm]	K [mm]	M Quantity - Nominal dia.	Tightening torque [N·m]
		Min.	Max.	Min.	Max.			Std.	Min.	Max.									
SFC-005DA2	C	3	6	3	6	16	-	23.2	21	40	7.85	1	-	4.8	2.5	6.5	6.5	1-M2	0.4 ~ 0.5
SFC-010DA2	C	3	8	3	8	19	-	25.9	24	45	9.15	1.05	-	5.8(6)	3.15	8.5	8.5	1-M2.5(M2)	1.0 ~ 1.1(0.4 ~ 0.5)
SFC-020DA2	C	4	10	4	11	26	-	32.3	29	50	10.75	1.65	-	9.5	3.3	10.6	10.6	1-M2.5	1.0 ~ 1.1
SFC-025DA2	C	5	14	5	14	29	-	32.8	29	50	10.75	1.9	-	11	3.3	15	14.5	1-M2.5	1.0 ~ 1.1
SFC-030DA2	A	5	10	5	10	34	21.6	37.8	34	55	12.4	2.5	8	-	3.75	15	14.5	1-M3	1.5 ~ 1.9
	B	5	10	Over10	16	34	21.6	37.8	34	55	12.4	2.5	8	12.5	3.75	15	14.5	1-M3	1.5 ~ 1.9
SFC-035DA2	C	Over10	14	Over10	16	34	-	37.8	34	55	12.4	2.5	-	12.5	3.75	15	14.5	1-M3	1.5 ~ 1.9
	C	6	16	6	19	39	-	48	43	65	15.5	3	-	14	4.5	17	17	1-M4	3.4 ~ 4.1
SFC-040DA2	A	8	15	8	15	44	29.6	48	43	65	15.5	3	11	-	4.5	20	19.5	1-M4	3.4 ~ 4.1
	B	8	15	Over15	24	44	29.6	48	43	65	15.5	3	11	17	4.5	20	19.5	1-M4	3.4 ~ 4.1
SFC-040DA2	C	Over15	19	Over15	24	44	-	48	43	65	15.5	3	-	17	4.5	20	19.5	1-M4	3.4 ~ 4.1
	A	8	19	8	19	56	38	59.8	53	80	20.5	2.4	14.5	-	6	26	26	1-M5	7.0 ~ 8.5
SFC-050DA2	B	8	19	Over19	30	56	38	59.8	53	80	20.5	2.4	14.5	22	6	26	26	1-M5	7.0 ~ 8.5
	C	Over19	25	Over19	30	56	-	59.8	53	80	20.5	2.4	-	22	6	26	26	1-M5	7.0 ~ 8.5
SFC-055DA2	C	10	30	10	30	63	-	68.7	60	85	24	2.6	-	23	7.75	31	31	1-M6	14 ~ 15
SFC-060DA2	A	11	24	11	24	68	46	73.3	65	90	25.2	3.2	17.5	-	7.75	31	31	1-M6	14 ~ 15
	B	11	24	Over24	35	68	46	73.3	65	90	25.2	3.2	17.5	26.5	7.75	31	31	1-M6	14 ~ 15
	C	Over24	30	Over24	35	68	-	73.3	65	90	25.2	3.2	-	26.5	7.75	31	31	1-M6	14 ~ 15

* Types A / B / C are automatically specified by Miki Pulley according to the combination of bore diameters you select, and cannot be specified by the customer. * The nominal diameter for the clamping bolt M is equal to the quantity minus the nominal diameter of the screw threads, where the quantity is for a hub on one side. * The figures in parentheses () for the SFC-010 are the values when d1 or d2 is ø8 mm. * Compatible lengths L range from the minimum L dimension to the maximum L dimension shown in the above table. Specify in 1 mm units. * When the L dimension is shorter than the standard, the left/right clamping bolt phases will be off by 45°. * Check "Standard Bore Diameters" for SFC (DA2) for the standard bore diameters.

How to Place an Order

SFC-040DA2-14B-15B-L60

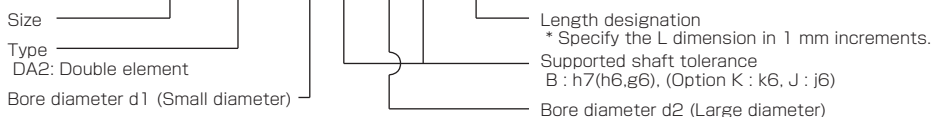

Option For keyway milling applications

If you are using a keyed shaft, we can mill a keyway in the clamping hub to your specifications.



Keyway milling standard

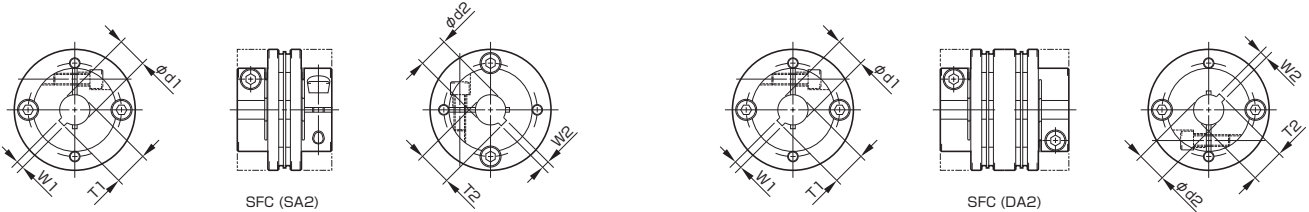

H9 keyway width standards										JS9 keyway width standards																	
Nominal bore dia. bore dia.	Shaft tolerance			Bore dia. d1·d2 [mm]	Keyway width W1·W2 [mm]	Keyway height T1·T2 [mm]	Nominal bore dia. bore dia.	Shaft tolerance			Bore dia. d1·d2 [mm]	Keyway width W1·W2 [mm]	Keyway height T1·T2 [mm]	Nominal bore dia. bore dia.	Shaft tolerance			Bore dia. d1·d2 [mm]	Keyway width W1·W2 [mm]	Keyway height T1·T2 [mm]							
	h7	j6	k6					h7	j6	k6					h7	j6	k6				h7	j6	k6				
8	BH	-	KH	8	3 ^{+0.025}	9.4 ^{+0.3}	20	BH	-	-	20	6 ^{+0.030}	22.8 ^{+0.3}	8	BJ	-	KJ	8	3 ^{±0.0125}	9.4 ^{+0.3}	20	BJ	-	-	20	6 ^{±0.0150}	22.8 ^{+0.3}
9	BH	-	KH	9	3 ^{+0.025}	10.4 ^{+0.3}	22	BH	JH	KH	22	6 ^{+0.030}	24.8 ^{+0.3}	9	BJ	-	KJ	9	3 ^{±0.0125}	10.4 ^{+0.3}	22	BJ	JJ	KJ	22	6 ^{±0.0150}	24.8 ^{+0.3}
10	BH	-	-	10	3 ^{+0.025}	11.4 ^{+0.3}	24	BH	JH	KH	24	8 ^{+0.036}	27.3 ^{+0.3}	10	BJ	-	-	10	3 ^{±0.0125}	11.4 ^{+0.3}	24	BJ	JJ	KJ	24	8 ^{±0.0180}	27.3 ^{+0.3}
11	BH	-	-	11	4 ^{+0.030}	12.8 ^{+0.3}	25	BH	-	-	25	8 ^{+0.036}	28.3 ^{+0.3}	11	BJ	-	-	11	4 ^{±0.0150}	12.8 ^{+0.3}	25	BJ	-	-	25	8 ^{±0.0180}	28.3 ^{+0.3}
12	BH	-	-	12	4 ^{+0.030}	13.8 ^{+0.3}	28	BH	JH	-	28	8 ^{+0.036}	31.3 ^{+0.3}	12	BJ	-	-	12	4 ^{±0.0150}	13.8 ^{+0.3}	28	BJ	JJ	-	28	8 ^{±0.0180}	31.3 ^{+0.3}
13	BH	-	-	13	5 ^{+0.030}	15.3 ^{+0.3}	30	BH	-	-	30	8 ^{+0.036}	33.3 ^{+0.3}	13	BJ	-	-	13	5 ^{±0.0150}	15.3 ^{+0.3}	30	BJ	-	-	30	8 ^{±0.0180}	33.3 ^{+0.3}
14	BH	-	KH	14	5 ^{+0.030}	16.3 ^{+0.3}	32	BH	-	KH	32	10 ^{+0.036}	35.3 ^{+0.3}	14	BJ	-	KJ	14	5 ^{±0.0150}	16.3 ^{+0.3}	32	BJ	-	KJ	32	10 ^{±0.0180}	35.3 ^{+0.3}
15	BH	-	-	15	5 ^{+0.030}	17.3 ^{+0.3}	35	BH	-	-	35	10 ^{+0.036}	38.3 ^{+0.3}	15	BJ	-	-	15	5 ^{±0.0150}	17.3 ^{+0.3}	35	BJ	-	-	35	10 ^{±0.0180}	38.3 ^{+0.3}
16	BH	-	KH	16	5 ^{+0.030}	18.3 ^{+0.3}	38	BH	-	KH	38	10 ^{+0.036}	41.3 ^{+0.3}	16	BJ	-	KJ	16	5 ^{±0.0150}	18.3 ^{+0.3}	38	BJ	-	KJ	38	10 ^{±0.0180}	41.3 ^{+0.3}
17	BH	-	-	17	5 ^{+0.030}	19.3 ^{+0.3}	40	BH	-	-	40	12 ^{+0.043}	43.3 ^{+0.3}	17	BJ	-	-	17	5 ^{±0.0150}	19.3 ^{+0.3}	40	BJ	-	-	40	12 ^{±0.0215}	43.3 ^{+0.3}
18	BH	-	-	18	6 ^{+0.030}	20.8 ^{+0.3}	42	BH	-	-	42	12 ^{+0.043}	45.3 ^{+0.3}	18	BJ	-	-	18	6 ^{±0.0150}	20.8 ^{+0.3}	42	BJ	-	-	42	12 ^{±0.0215}	45.3 ^{+0.3}
19	BH	JH	KH	19	6 ^{+0.030}	21.8 ^{+0.3}	45	BH	-	-	45	14 ^{+0.043}	48.8 ^{+0.3}	19	BJ	JJ	KJ	19	6 ^{±0.0150}	21.8 ^{+0.3}	45	BJ	-	-	45	14 ^{±0.0215}	48.8 ^{+0.3}

*Bore diameter of φ35 (nominal diameter B), the shaft tolerance is ^{+0.010}/_{-0.025}. * We can also handle standards not listed above. Consult MIKI PULLEY.

Standard bore diameters

		Standard (option) bore diameter, d1/d2 [mm] and restricted rated torque [N·m]																							
Nominal bore dia.		8	9	10	11	12	13	14	15	16	17	18	19	20	22	24	25	28	30	32	35	38	40	42	45
Shaft tolerance	h7 (h6,g6)	B	●	●	●	●	●	●	●	●	●	●	●	●	●	●	●	●	●	●	●	●	●	●	●
	j6 (Option)	J													○	○	○	○							
	k6 (Option)	K	○	○					○	○					○	○	○			○	○				
Supported bore diameter for each model	SFC-025SA2/DA2	d1	●	●	●	●	●	●																	
		d2	●	●	●	●	●	●	●																
SFC-030SA2/DA2	d1	●	●	●	●	●	●	●																	
	d2	●	●	●	●	●	●	●	●																
SFC-035SA2/DA2	d1	●	●	●	●	●	●	●	●	●															
	d2	●	●	●	●	●	●	●	●	●	●	●	●												
SFC-040SA2/DA2	d1	9	●	●	●	●	●	●	●	●	●	●	●	●	●	●	●	●	●	●	●	●	●	●	●
	d2	9	●	●	●	●	●	●	●	●	●	●	●	●	●	●	●	●	●	●	●	●	●	●	●
SFC-050SA2/DA2	d1	18	20	22	●	●	●	●	●	●	●	●	●	●	●	●	●	●	●	●	●	●	●	●	●
	d2	18	20	22	●	●	●	●	●	●	●	●	●	●	●	●	●	●	●	●	●	●	●	●	●
SFC-055SA2/DA2	d1			31	34	36	38	●	●	●	●	●	●	●	●	●	●	●	●	●	●	●	●	●	●
	d2			31	34	36	38	●	●	●	●	●	●	●	●	●	●	●	●	●	●	●	●	●	●
SFC-060SA2/DA2	d1				50	51	●	●	●	●	●	●	●	●	●	●	●	●	●	●	●	●	●	●	●
	d2				50	51	●	●	●	●	●	●	●	●	●	●	●	●	●	●	●	●	●	●	●
SFC-080SA2/DA2	d1																								
	d2																								
SFC-090SA2/DA2	d1																								
	d2																								
SFC-100SA2/DA2	d1																								
	d2																					226	●	●	●

* The shaft tolerance for standard bore diameter is h7 (h6 or g6): designation B. However, for a bore diameter of φ35, the shaft tolerance is ^{+0.010}/_{-0.025}. * Shaft tolerances j6/k6: designations J/K are optional, and are only supported for bore diameters marked with ●. * Bore diameters marked with ● or numbers are supported as the standard bore diameters. Consult Miki Pulley regarding special arrangements which may be possible for other bore diameters. * Bore diameters whose fields contain numbers are restricted in their rated torque by the holding power of the shaft connection component because the bore diameter is small. The numbers indicate the rated torque [N·m].

How to Place an Order

SFC-060SA2-12BH-14KJ

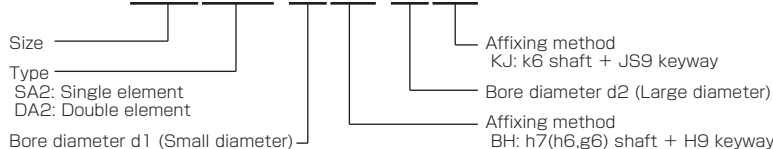

* For nominal bore diameter, select d1 (small diameter) -d2 (large diameter) in that order.
* If d1=d2 (same diameters), select B · J · K in that order.
B · J · K · BH · BJ · JH · JJ · KH · KJ

Option Clean room compatible / Single element type

It is a clean room compatible product that has been cleaned, assembled (ISO class 6) and packed in consideration of its use in clean rooms.

Specifications

Mode	Shape type	Rated torque [N·m]	Misalignment			Max. rotation speed [min ⁻¹]	Torsional stiffness [N·m/rad]	Axial stiffness [N/mm]	Moment of inertia [kg·m ²]	Mass [kg]
			Parallel [mm]	Angular [°]	Axial [mm]					
SFC-030SA2	A	5	0.02	1	±0.2	10000	8000	64	4.09×10 ⁻⁶	0.034
	B	5	0.02	1	±0.2	10000	8000	64	6.11×10 ⁻⁶	0.040
	C	5	0.02	1	±0.2	10000	8000	64	8.23×10 ⁻⁶	0.048
SFC-035SA2	C	10	0.02	1	±0.25	10000	18000	112	18.50×10 ⁻⁶	0.083
SFC-040SA2	A	12	0.02	1	±0.3	10000	20000	80	16.71×10 ⁻⁶	0.077
	B	12	0.02	1	±0.3	10000	20000	80	22.59×10 ⁻⁶	0.085
	C	12	0.02	1	±0.3	10000	20000	80	29.28×10 ⁻⁶	0.100
SFC-050SA2	A	25	0.02	1	±0.4	10000	32000	48	56.26×10 ⁻⁶	0.160
	B	25	0.02	1	±0.4	10000	32000	48	76.71×10 ⁻⁶	0.178
	C	25	0.02	1	±0.4	10000	32000	48	99.38×10 ⁻⁶	0.207
SFC-055SA2	C	40	0.02	1	±0.42	10000	50000	43	188.7×10 ⁻⁶	0.315
SFC-060SA2	A	60	0.02	1	±0.45	10000	70000	76.4	147.0×10 ⁻⁶	0.285
	B	60	0.02	1	±0.45	10000	70000	76.4	206.3×10 ⁻⁶	0.328
	C	60	0.02	1	±0.45	10000	70000	76.4	270.0×10 ⁻⁶	0.387
SFC-080SA2	C	100	0.02	1	±0.55	10000	140000	128	716.3×10 ⁻⁶	0.720

* Types A / B / C are automatically specified by Miki Pulley according to the combination of bore diameters you select, and cannot be specified by the customer. * Check the Standard Bore Diameter list as rated torque may be restricted by the holding power of the shaft connection component. * Max. rotation speed does not take into account dynamic balance. * Torsional stiffness values given are measured values for the element alone. * The moment of inertia and mass are measured for the maximum bore diameter.

Dimensions

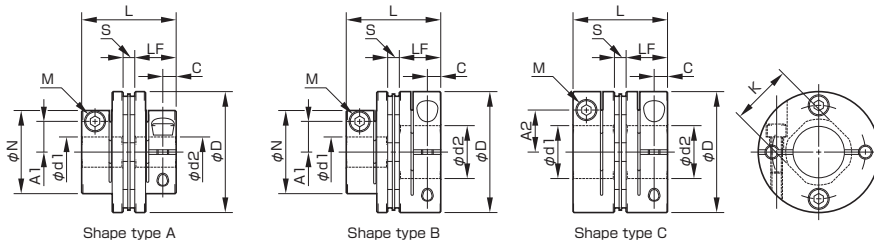

Model	Shape type	d1 [mm]		d2 [mm]		D [mm]	N [mm]	L [mm]	LF [mm]	S [mm]	A1 [mm]	A2 [mm]	C [mm]	K [mm]	M Quantity - Nominal dia.	Tightening torque [N·m]	
		Min.	Max.	Min.	Max.											CC Low dust	CF Fluorine
SFC-030SA2	A	5	10	5	10	34	21.6	27.3	12.4	2.5	8	-	3.75	14.5	1-M3	1.5	3.2
	B	5	10	Over10	16	34	21.6	27.3	12.4	2.5	8	12.5	3.75	14.5	1-M3	1.5	3.2
	C	Over10	14	Over10	16	34	-	27.3	12.4	2.5	-	12.5	3.75	14.5	1-M3	1.5	3.2
SFC-035SA2	C	6	16	6	19	39	-	34	15.5	3	-	14	4.5	17	1-M4	4	7.7
SFC-040SA2	A	8	15	8	15	44	29.6	34	15.5	3	11	-	4.5	19.5	1-M4	4	7.7
	B	8	15	Over15	24	44	29.6	34	15.5	3	11	17	4.5	19.5	1-M4	4	7.7
	C	Over15	19	Over15	24	44	-	34	15.5	3	-	17	4.5	19.5	1-M4	4	7.7
SFC-050SA2	A	8	19	8	19	56	38	43.4	20.5	2.4	14.5	-	6	26	1-M5	7	12
	B	8	19	Over19	30	56	38	43.4	20.5	2.4	14.5	22	6	26	1-M5	7	12
	C	Over19	25	Over19	30	56	-	43.4	20.5	2.4	-	22	6	26	1-M5	7	12
SFC-055SA2	C	10	30	10	30	63	-	50.6	24	2.6	-	23	7.75	31	1-M6	13	22.5
SFC-060SA2	A	11	24	11	24	68	46	53.6	25.2	3.2	17.5	-	7.75	31	1-M6	13	22.5
	B	11	24	Over24	35	68	46	53.6	25.2	3.2	17.5	26.5	7.75	31	1-M6	13	22.5
	C	Over24	30	Over24	35	68	-	53.6	25.2	3.2	-	26.5	7.75	31	1-M6	13	22.5
SFC-080SA2	C	18	35	18	40	82	-	68	30	8	-	28	9	38	1-M8	27	45

* Types A / B / C are automatically specified by Miki Pulley according to the combination of bore diameters you select, and cannot be specified by the customer. * The K dimension is the inner diameter of the element. For d2 dimension exceeding this value, shaft can be inserted only up to LF dimension to the d2 side hub. * The nominal diameter for the clamping bolt M is equal to the quantity minus the nominal diameter of the screw threads, where the quantity is for a hub on one side. * You can choose from two types of grease for clamp bolts: low dust generation grease and fluorine grease.



Standard bore diameters (Low dust generation grease)

Model	Standard bore diameter, d1/d2 [mm] and restricted rated torque [N·m]																													
	d1·d2	5	6	6.35	7	8	9	9.525	10	11	12	13	14	15	16	17	18	19	20	22	24	25	28	30	32	35	38	40		
SFC-030SA2	d1	0.8	1.6	2	2.6	3.4	4.4	4.9	●	●	●	●	●																	
	d2	0.8	1.6	2	2.6	3.4	4.4	4.9	●	●	●	●	●	●	●															
SFC-035SA2	d1		3.3	3.8	4.8	6.3	7.7	8.5	9.2	●	●	●	●	●	●															
	d2		3.3	3.8	4.8	6.3	7.7	8.5	9.2	●	●	●	●	●	●	●	●	●												
SFC-040SA2	d1					9	9	9	9	9	●	●	●	●	●	●	●	●												
	d2					9	9	9	9	9	●	●	●	●	●	●	●	●	●	●	●	●								
SFC-050SA2	d1					11	16	17	19	19	24	24	24	●	●	●	●	●	●	●	●	●	●	●	●	●	●	●	●	
	d2					11	16	17	19	19	24	24	24	●	●	●	●	●	●	●	●	●	●	●	●	●	●	●	●	
SFC-055SA2	d1									20	24	29	33	37	●	●	●	●	●	●	●	●	●	●	●	●	●	●		
	d2									20	24	29	33	37	●	●	●	●	●	●	●	●	●	●	●	●	●	●		
SFC-060SA2	d1										38	41	44	48	55	55	58	●	●	●	●	●	●	●	●	●	●	●		
	d2										38	41	44	48	55	55	58	●	●	●	●	●	●	●	●	●	●	●		
SFC-080SA2	d1																	54	60	65	75	85	90	●	●	●	●	●		
	d2																	54	60	65	75	85	90	●	●	●	●	●		

* The shaft tolerance for standard bore diameter is h7 (h6 or g6): designation B. However, for a bore diameter of ø35, the shaft tolerance is $^{+0.010}_{-0.025}$. * Bore diameters marked with ● or numbers are supported as the standard bore diameters. Consult Miki Pulley regarding special arrangements which may be possible for other bore diameters. * Bore diameters whose fields contain numbers are restricted in their rated torque by the holding power of the shaft connection component because the bore diameter is small. The numbers indicate the rated torque [N·m].

Standard bore diameters (Fluorine grease)

型式	Standard bore diameter, d1/d2 [mm] and restricted rated torque [N·m]																													
	d1·d2	5	6	6.35	7	8	9	9.525	10	11	12	13	14	15	16	17	18	19	20	22	24	25	28	30	32	35	38	40		
SFC-030SA2	d1	0.8	2	2.4	3.1	4.3	●	●	●	●	●	●	●	●	●															
	d2	0.8	2	2.4	3.1	4.3	●	●	●	●	●	●	●	●	●	●														
SFC-035SA2	d1		3.6	5.2	6.4	8.2	●	●	●	●	●	●	●	●	●	●														
	d2		3.6	5.2	6.4	8.2	●	●	●	●	●	●	●	●	●	●	●	●	●	●	●	●								
SFC-040SA2	d1					●	●	●	●	●	●	●	●	●	●	●	●	●	●	●	●	●	●	●	●	●	●	●	●	
	d2					●	●	●	●	●	●	●	●	●	●	●	●	●	●	●	●	●	●	●	●	●	●	●	●	
SFC-050SA2	d1					11	17	19	20	22	●	●	●	●	●	●	●	●	●	●	●	●	●	●	●	●	●	●	●	
	d2					11	17	19	20	22	●	●	●	●	●	●	●	●	●	●	●	●	●	●	●	●	●	●	●	
SFC-055SA2	d1									28	37	●	●	●	●	●	●	●	●	●	●	●	●	●	●	●	●	●		
	d2									28	37	●	●	●	●	●	●	●	●	●	●	●	●	●	●	●	●	●		
SFC-060SA2	d1										40	44	49	53	●	●	●	●	●	●	●	●	●	●	●	●	●	●		
	d2										40	44	49	53	●	●	●	●	●	●	●	●	●	●	●	●	●	●		
SFC-080SA2	d1																		60	66	71	81	90	95	●	●	●	●		
	d2																		60	66	71	81	90	95	●	●	●	●		

* The shaft tolerance for standard bore diameter is h7 (h6 or g6): designation B. However, for a bore diameter of ø35, the shaft tolerance is $^{+0.010}_{-0.025}$. * Bore diameters marked with ● or numbers are supported as the standard bore diameters. Consult Miki Pulley regarding special arrangements which may be possible for other bore diameters. * Bore diameters whose fields contain numbers are restricted in their rated torque by the holding power of the shaft connection component because the bore diameter is small. The numbers indicate the rated torque [N·m].

How to Place an Order

SFC-030SA2-CC-10B-14B

Size
Type
SA2: Single element
Grease type
CC: Low dust generation grease
CF: Fluorine grease

Supported shaft tolerance
B : h7(h6,g6) shaft

* Bore diameter of ø35, the shaft tolerance is $^{+0.010}_{-0.025}$.
* For nominal bore diameter, select d1 (small dia.)-d2 (large dia.) in that order.

Bore diameter d2 (Large diameter)

Bore diameter d1 (Small diameter)

Option Clean room compatible / Double element type

It is a clean room compatible product that has been cleaned, assembled (ISO class 6) and packed in consideration of its use in clean rooms.

Specifications

Model	Shape type	Rated torque [N·m]	Misalignment			Max. rotation speed [min ⁻¹]	Torsional stiffness [N·m/rad]	Axial stiffness [N/mm]	Moment of inertia [kg·m ²]	Mass [kg]
			Parallel [mm]	Angular [°]	Axial [mm]					
SFC-030DA2	A	5	0.18	1 (On one side)	±0.4	10000	4000	32	7.46×10 ⁻⁶	0.054
	B	5	0.18	1 (On one side)	±0.4	10000	4000	32	9.49×10 ⁻⁶	0.060
	C	5	0.18	1 (On one side)	±0.4	10000	4000	32	11.60×10 ⁻⁶	0.069
SFC-035DA2	C	10	0.24	1 (On one side)	±0.5	10000	9000	56	27.03×10 ⁻⁶	0.122
SFC-040DA2	A	12	0.24	1 (On one side)	±0.6	10000	10000	40	30.03×10 ⁻⁶	0.124
	B	12	0.24	1 (On one side)	±0.6	10000	10000	40	35.91×10 ⁻⁶	0.132
	C	12	0.24	1 (On one side)	±0.6	10000	10000	40	42.60×10 ⁻⁶	0.147
SFC-050DA2	A	25	0.28	1 (On one side)	±0.8	10000	16000	24	99.32×10 ⁻⁶	0.252
	B	25	0.28	1 (On one side)	±0.8	10000	16000	24	119.8×10 ⁻⁶	0.270
	C	25	0.28	1 (On one side)	±0.8	10000	16000	24	142.4×10 ⁻⁶	0.299
SFC-055DA2	C	40	0.31	1 (On one side)	±0.84	10000	25000	21.5	262.3×10 ⁻⁶	0.436
SFC-060DA2	A	60	0.34	1 (On one side)	±0.9	10000	35000	38.2	258.6×10 ⁻⁶	0.450
	B	60	0.34	1 (On one side)	±0.9	10000	35000	38.2	317.8×10 ⁻⁶	0.493
	C	60	0.34	1 (On one side)	±0.9	10000	35000	38.2	381.6×10 ⁻⁶	0.552
SFC-080DA2	C	100	0.52	1 (On one side)	±1.10	10000	70000	64	1047×10 ⁻⁶	1.050

* Types A / B / C are automatically specified by Miki Pulley according to the combination of bore diameters you select, and cannot be specified by the customer. * Check the Standard Bore Diameter list as rated torque may be restricted by the holding power of the shaft connection component. * Max. rotation speed does not take into account dynamic balance. * Torsional stiffness values given are measured values for the element alone. * The moment of inertia and mass are measured for the maximum bore diameter.

Dimensions

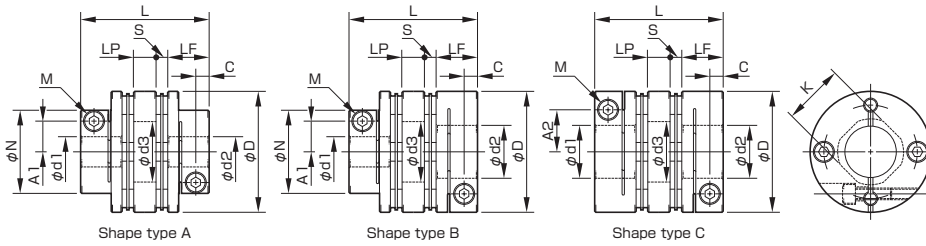

Model	Shape type	d1 [mm]		d2 [mm]		D [mm]	N [mm]	L [mm]	LF [mm]	LP [mm]	S [mm]	A1 [mm]	A2 [mm]	C [mm]	d3 [mm]	K [mm]	M Quantity - Nominal dia.	Tightening torque [N·m]	
		Min.	Max.	Min.	Max.													CC Low dust	CF Fluorine
SFC-030DA2	A	5	10	5	10	34	21.6	27.3	12.4	8	2.5	8	-	3.75	15	14.5	1-M3	1.5	3.2
	B	5	10	Over10	16	34	21.6	27.3	12.4	8	2.5	8	12.5	3.75	15	14.5	1-M3	1.5	3.2
	C	Over10	14	Over10	16	34	-	27.3	12.4	8	2.5	-	12.5	3.75	15	14.5	1-M3	1.5	3.2
SFC-035DA2	C	6	16	6	19	39	-	34	15.5	11	3	-	14	4.5	17	17	1-M4	4	7.7
SFC-040DA2	A	8	15	8	15	44	29.6	34	15.5	11	3	11	-	4.5	20	19.5	1-M4	4	7.7
	B	8	15	Over15	24	44	29.6	34	15.5	11	3	11	17	4.5	20	19.5	1-M4	4	7.7
	C	Over15	19	Over15	24	44	-	34	15.5	11	3	-	17	4.5	20	19.5	1-M4	4	7.7
SFC-050DA2	A	8	19	8	19	56	38	43.4	20.5	14	2.4	14.5	-	6	26	26	1-M5	7	12
	B	8	19	Over19	30	56	38	43.4	20.5	14	2.4	14.5	22	6	26	26	1-M5	7	12
	C	Over19	25	Over19	30	56	-	43.4	20.5	14	2.4	-	22	6	26	26	1-M5	7	12
SFC-055DA2	C	10	30	10	30	63	-	50.6	24	15.5	2.6	-	23	7.75	31	31	1-M6	13	22.5
SFC-060DA2	A	11	24	11	24	68	46	53.6	25.2	16.5	3.2	17.5	-	7.75	31	31	1-M6	13	22.5
	B	11	24	Over24	35	68	46	53.6	25.2	16.5	3.2	17.5	26.5	7.75	31	31	1-M6	13	22.5
	C	Over24	30	Over24	35	68	-	53.6	25.2	16.5	3.2	-	26.5	7.75	31	31	1-M6	13	22.5
SFC-080DA2	C	18	35	18	40	82	-	68	30	22	8	-	28	9	40	38	1-M8	27	45

* Types A / B / C are automatically specified by Miki Pulley according to the combination of bore diameters you select, and cannot be specified by the customer. * The K dimension is the inner diameter of the element. For d2 dimension exceeding this value, shaft can be inserted only up to LF dimension to the d2 side hub. * The nominal diameter for the clamping bolt M is equal to the quantity minus the nominal diameter of the screw threads, where the quantity is for a hub on one side. * You can choose from two types of grease for clamp bolts: low dust generation grease and fluorine grease.



Standard bore diameters (Low dust generation grease)

Model	Standard bore diameter, d1/d2 [mm] and restricted rated torque [N·m]																													
	d1·d2	5	6	6.35	7	8	9	9.525	10	11	12	13	14	15	16	17	18	19	20	22	24	25	28	30	32	35	38	40		
SFC-030DA2	d1	0.8	1.6	2	2.6	3.4	4.4	4.9	●	●	●	●	●																	
	d2	0.8	1.6	2	2.6	3.4	4.4	4.9	●	●	●	●	●	●	●															
SFC-035DA2	d1		3.3	3.8	4.8	6.3	7.7	8.5	9.2	●	●	●	●	●	●															
	d2		3.3	3.8	4.8	6.3	7.7	8.5	9.2	●	●	●	●	●	●	●	●	●												
SFC-040DA2	d1					9	9	9	9	9	●	●	●	●	●	●	●	●												
	d2					9	9	9	9	9	●	●	●	●	●	●	●	●	●	●	●	●								
SFC-050DA2	d1					11	16	17	19	19	24	24	24	●	●	●	●	●	●	●	●	●	●	●	●	●	●	●	●	
	d2					11	16	17	19	19	24	24	24	●	●	●	●	●	●	●	●	●	●	●	●	●	●	●	●	
SFC-055DA2	d1									20	24	29	33	37	●	●	●	●	●	●	●	●	●	●	●	●	●	●	●	
	d2									20	24	29	33	37	●	●	●	●	●	●	●	●	●	●	●	●	●	●	●	
SFC-060DA2	d1										38	41	44	48	55	55	58	●	●	●	●	●	●	●	●	●	●	●	●	
	d2										38	41	44	48	55	55	58	●	●	●	●	●	●	●	●	●	●	●	●	
SFC-080DA2	d1																	54	60	65	75	85	90	●	●	●	●	●		
	d2																	54	60	65	75	85	90	●	●	●	●	●		

* The shaft tolerance for standard bore diameter is h7 (h6 or g6): designation B. However, for a bore diameter of ø35, the shaft tolerance is $^{+0.010}_{-0.025}$. * Bore diameters marked with ● or numbers are supported as the standard bore diameters. Consult Miki Pulley regarding special arrangements which may be possible for other bore diameters. * Bore diameters whose fields contain numbers are restricted in their rated torque by the holding power of the shaft connection component because the bore diameter is small. The numbers indicate the rated torque [N·m].

Standard bore diameters (Fluorine grease)

Model	Standard bore diameter, d1/d2 [mm] and restricted rated torque [N·m]																													
	d1·d2	5	6	6.35	7	8	9	9.525	10	11	12	13	14	15	16	17	18	19	20	22	24	25	28	30	32	35	38	40		
SFC-030DA2	d1	0.8	2	2.4	3.1	4.3	●	●	●	●	●	●	●																	
	d2	0.8	2	2.4	3.1	4.3	●	●	●	●	●	●	●	●	●															
SFC-035DA2	d1		3.6	5.2	6.4	8.2	●	●	●	●	●	●	●	●	●															
	d2		3.6	5.2	6.4	8.2	●	●	●	●	●	●	●	●	●	●	●	●												
SFC-040DA2	d1					●	●	●	●	●	●	●	●	●	●	●	●	●	●	●	●	●	●	●	●	●	●	●	●	
	d2					●	●	●	●	●	●	●	●	●	●	●	●	●	●	●	●	●	●	●	●	●	●	●	●	
SFC-050DA2	d1					11	17	19	20	22	●	●	●	●	●	●	●	●	●	●	●	●	●	●	●	●	●	●	●	
	d2					11	17	19	20	22	●	●	●	●	●	●	●	●	●	●	●	●	●	●	●	●	●	●	●	
SFC-055DA2	d1									28	37	●	●	●	●	●	●	●	●	●	●	●	●	●	●	●	●	●	●	
	d2									28	37	●	●	●	●	●	●	●	●	●	●	●	●	●	●	●	●	●	●	
SFC-060DA2	d1										40	44	49	53	●	●	●	●	●	●	●	●	●	●	●	●	●	●	●	
	d2										40	44	49	53	●	●	●	●	●	●	●	●	●	●	●	●	●	●	●	
SFC-080DA2	d1																	60	66	71	81	90	95	●	●	●	●	●		
	d2																	60	66	71	81	90	95	●	●	●	●	●		

* The shaft tolerance for standard bore diameter is h7 (h6 or g6): designation B. However, for a bore diameter of ø35, the shaft tolerance is $^{+0.010}_{-0.025}$. * Bore diameters marked with ● or numbers are supported as the standard bore diameters. Consult Miki Pulley regarding special arrangements which may be possible for other bore diameters. * Bore diameters whose fields contain numbers are restricted in their rated torque by the holding power of the shaft connection component because the bore diameter is small. The numbers indicate the rated torque [N·m].

How to Place an Order

SFC-030DA2-CC-10B-14B

Size ———
 Type ———
 DA2: Double element
 Grease type ———
 CC: Low dust generation grease
 CF: Fluorine grease

Supported shaft tolerance
 B : h7(h6,g6) shaft

* Bore diameter of ø35, the shaft tolerance is $^{+0.010}_{-0.025}$.
 * For nominal bore diameter, select d1 (small dia.)-d2 (large dia.) in that order.

Bore diameter d2 (Large diameter)

Bore diameter d1 (Small diameter)

Items Checked for Design Purposes

Spring characteristics SFC (SA2)

■ Axial load and amount of displacement

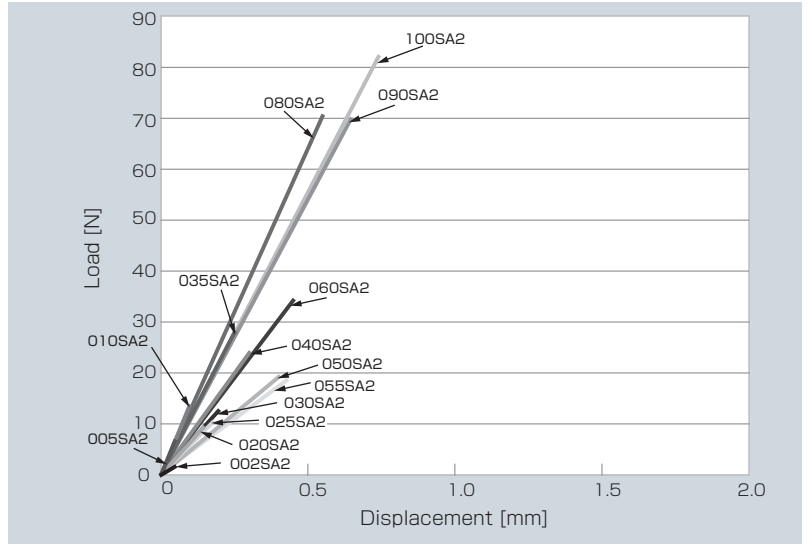
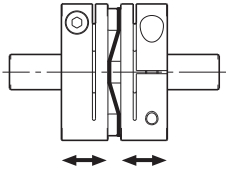

Spring characteristics SFC (DA2)

■ Axial load and amount of displacement

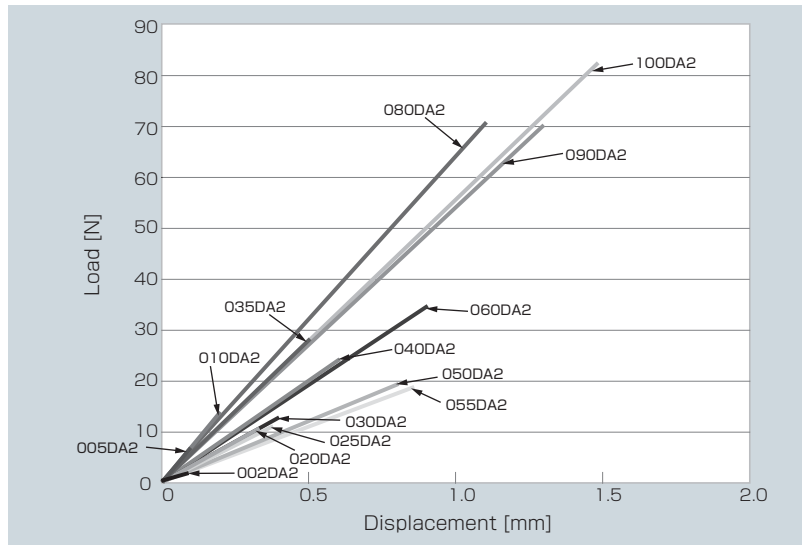
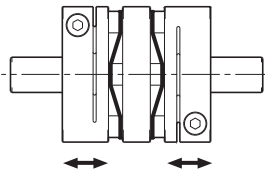

■ Parallel misalignment direction load and amount of displacement

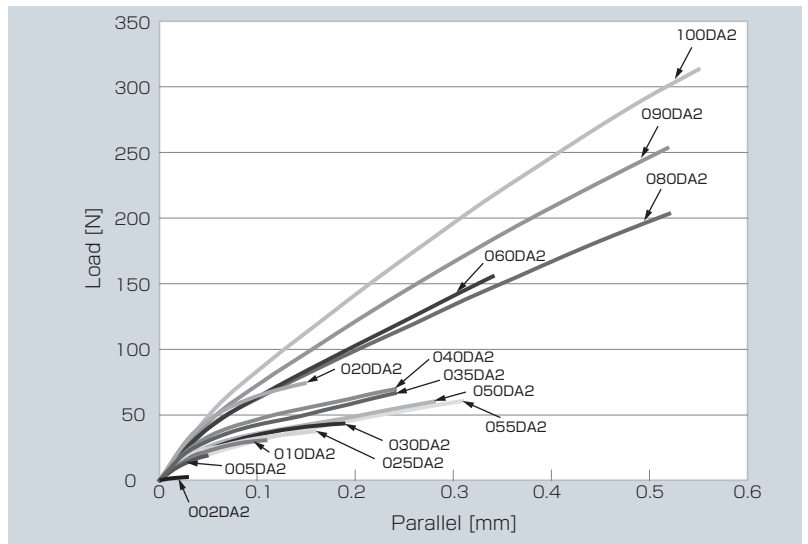
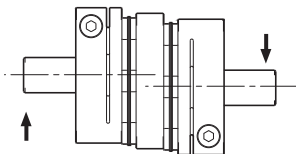

Special items to take note of

You should note the following to prevent any problems.

- (1) Always be careful of parallel, angular, and axial misalignment.
- (2) Always tighten bolts with the specified torque.

Precautions for handling

Couplings are assembled at high accuracy using a special mounting jig to ensure accurate concentricity of left and right internal diameters.

Take extra precautions when handling couplings, should strong shocks be given on couplings, it may affect mounting accuracy and cause the parts to break during use.

- (1) Couplings are designed for use within an operating temperature range of -30°C to 100°C . Although the couplings are designed to be waterproof and oil proof, do not subject them to excessive amounts of water and oil as it may cause part deterioration.
- (2) Handle the element with care as it is made of a thin stainless steel metal disc, also making sure to be careful so as not to injure yourself.
- (3) Do not tighten up clamp bolts until after inserting the mounting shaft.
- (4) Mounting shaft is assumed to be a round shaft.

Mounting

- (1) Check that coupling clamping bolts have been loosened and remove any rust, dust, oil residue, etc. from inner diameter surfaces of the shaft and couplings. In particular, never allow oil or grease containing antifriction or other agent (molybdenum-, silicon-, or fluorine-based), which would dramatically affect the friction coefficient, to contact the surface.
- (2) Be careful when inserting the couplings into the shaft so as not to apply excessive force of compression or tensile force to the element. Be particularly careful not to apply excessive compressing force needlessly when inserting couplings into the paired shaft after attaching the couplings to the motor.
- (3) With two of the clamp bolts loosened, make sure that couplings move gently along the axial and rotational directions. Readjust the centering of the two shafts if the couplings fail to move smoothly enough. This method is recommended as a way to easily check the concentricity of the left and right sides. If unable to use the same method, check the mounting accuracy using machine parts quality control procedures or an alternative method.

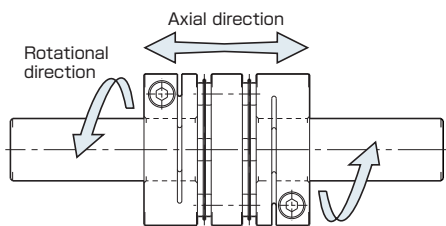

- (4) As a general rule, round shafts are to be used for the paired mounting shaft. If needing to use a shaft with a different shape, be careful not to insert it into any of the locations indicated in the diagrams below. (Grayed areas indicate areas wherein clamping hub shifts when clamped. Do not allow keyways, D-shaped cuts, or other insertions in these areas.) Placing the shaft in an undesirable location may cause the couplings to break or lead to a loss in shaft holding power. It is recommended that you use only round shafts to ensure full utilization of the entire range of coupling performance.

Proper mounting examples

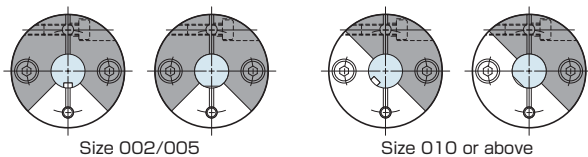

Poor mounting examples

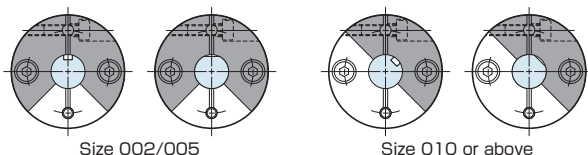

- (5) Insert and mount each shaft far enough in that the paired mounting shaft touches the shaft along the entire length of the clamping hub of the coupling (LF dimension), as shown in the diagram below, and does not interfere with the elements, spacers or the other shaft. In addition, restrict the dimensions between clamping hub faces (S dimensions in the diagram) within the allowable misalignment of the axial direction displacement with respect to a reference value. Note that the tolerance values were calculated based on the assumption that both the level of parallel misalignment and angular deflection are zero. Adjust to keep this value as low as possible.

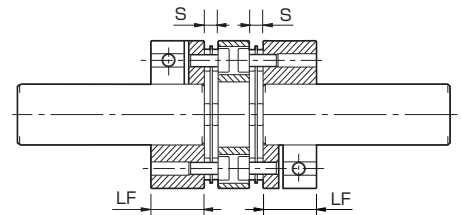

Model	LF [mm]	S [mm]
SFC-002	5.9	0.55
SFC-005	7.85	1
SFC-010	9.15	1.05
SFC-020	10.75	1.65
SFC-025	10.75	1.9
SFC-030	12.4	2.5
SFC-035	15.5	3
SFC-040	15.5	3
SFC-050	20.5	2.4
SFC-055	24	2.6
SFC-060	25.2	3.2
SFC-080	30	8
SFC-090	30	8.3
SFC-100	30	9.8

- (6) Check to make sure that no compression or tensile force is being applied along the axial direction before tightening up the two clamp bolts. Use a calibrated torque wrench to tighten the clamp bolts to within the tightening torque range listed below.

Model	Nominal bolt dia.	Tightening torque [N·m]		
		Standard	CC Low dust	CF Fluorine
SFC-002	M1.6	0.23 ~ 0.28	-	-
SFC-005 (SFC-010)	M2	0.4 ~ 0.5	-	-
SFC-010 · 020 · 025	M2.5	1.0 ~ 1.1	-	-
SFC-030	M3	1.5 ~ 1.9	1.5	3.2
SFC-035 · 040	M4	3.4 ~ 4.1	4	7.7
SFC-050	M5	7.0 ~ 8.5	7	12
SFC-055 · 060	M6	14 ~ 15	13	22.5
SFC-080 · 090 · 100	M8	27 ~ 30	27	45

* Use M2 bolts on SFC-010SA2/DA2 models with holes with a diameter of $\phi 8$ mm.
* The start and end numbers for the tightening torque ranges are between the minimum and maximum values. Tighten bolts to a tightening torque within the specified range for the model used.

Suitable torque screwdriver / torque wrench

Nominal bolt dia.	Standard / CC Low dust		CF Fluorine	
	Torque screwdriver / wrench	Hexagon bit / head	Torque screwdriver / wrench	Hexagon bit / head
M1.6	CN30LTDK	CB 1.5mm	-	-
M2	CN60LTDK	SB 1.5mm	-	-
M2.5	CN120LTDK	SB 2mm	-	-
M3	CN200LTDK	SB 2.5mm	CN500LTDK	SB 2.5mm
M4	CN500LTDK	SB 3mm	N10LTDK	SB 3mm
M5	N10LTDK	SB 4mm	N25LCK	25HCK 4mm
M6	N25LCK	25HCK 5mm	N25LCK	25HCK 5mm
M8	N50LCK	50HCK 6mm	N50LCK	50HCK 6mm

* Torque driver (wrench) , Hexagon bit (head) models indicated above are the products of NAKAMURA SEISAKUSYO Co., Ltd.

Items Checked for Design Purposes

Length-specified special order parts option

Specify any length for the length-specified special order option for the SERVOFLEX SFC (DA2). Use the following formula to calculate the allowable parallel misalignment value, adjust it to be no greater than that value, and then mount the coupling.

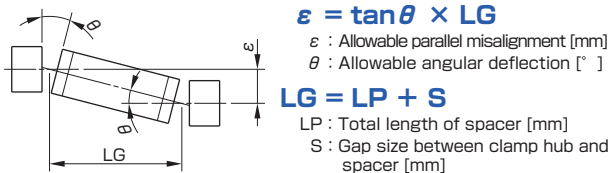

Options for keyway milling

Options for keyway milling are available on request. However, because they are designed such that torque is transferred to the friction coupling by the clamp mechanism, care should be taken not to exceed the coupling's permitted torque during use. Note also the following issues:

- (1) Only ever use keys that are no wider than the keyway. Using keys that are a tight fit could result in damage during mounting or operation.
- (2) The positional accuracy of keyway milling is visual. If positional accuracy relative to keyway hubs is required, contact Miki Pulley.
- (3) Using JS9 class tolerances provides a tight fit, so couplings may be compressed when mounted on shafts. Take care not to further compress the couplings.
- (4) Setting the fit of the key and keyway too loosely may result in play that generates dust. Also take care that the key does not come loose.
- (5) Adding a set screw over the keyway is not recommended as it may lower clamp performance, and the set screw may also become loose within the torque range you use or during forward/reverse operation. It may also impair the structural strength of the clamping hub or damage the coupling.

Selection order of nominal bore diameters when ordering

When specifying bore diameters, you should basically specify d1 (small diameter)-d2 (large diameter), and always specify d2 for taper adapters mounted on tapered shafts. However, where d1=d2 (same diameters), note the selection order below for each nominal bore diameter when ordering.

Nominal bore diameter symbol	Shaft tolerance	Keyway tolerance	Type	Selection diameter	Selection order
B	h7 (h6,g6)	-	Standard	d1/d2	1
J	j6	-	Option	d1/d2	2
K	k6	-	Option	d1/d2	3
BH	h7 (h6,g6)	H9	Option	d1/d2	4
BJ	h7 (h6,g6)	JS9	Option	d1/d2	5
JH	j6	H9	Option	d1/d2	6
JJ	j6	JS9	Option	d1/d2	7
KH	k6	H9	Option	d1/d2	8
KJ	k6	JS9	Option	d1/d2	9
BC	Tapered shaft supported		Option	d2	10

Clamp bolts

Use MIKI PULLEY-specified clamp bolts because they are processed with solid lubricant coating (except for SFC-002 M1.6). Applying adhesives to prevent loosening, oil, or the like to a clamp bolt will alter torque coefficients due to those lubricating components, creating excessive axial forces and potentially damaging the clamp bolt or coupling. Consult MIKI PULLEY before using such products.

Surface processing of coupling bore diameter

The bore diameters may or may not have surface processing in some components due to the circumstances of processing. This does not affect coupling performance. Consult Miki Pulley if your usage conditions require that bore diameters be surface processed or not.

Points to consider regarding the feed screw system

In feed screw systems using a stepper motor or servo motor, the pulsation natural frequency of the stepper motor and the torsional natural frequency of the system as a whole may cause the system to resonate, or the gain adjustment of the servo motor may cause the system to oscillate.

If resonance occurs, the resonant rotation speed must be skipped, or if oscillation occurs, adjustment will need to be made such as by using the filter function or other electrical control system to resolve the issue.

In either instance, to handle resonance and oscillation, it will be necessary to take into account the torsional natural frequency for the system overall during the design stage, including the torsional stiffness for the coupling and feed screw section and the moment of inertia and other characteristics.

How to find the natural frequency of a feed screw system

Select a coupling based on the standard torque or maximum torque of the servo motor.

Next, find the overall natural frequency, Nf, from the torsional stiffness of the coupling and feed screw, K, the moment of inertia of driving side, J1, and the moment of inertia of driven side, J2, for the feed screw system shown below.

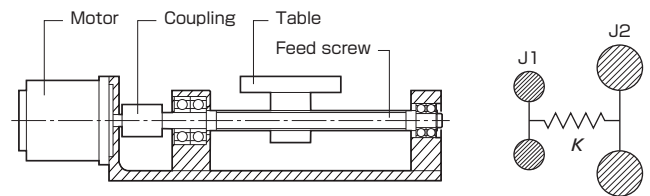

Natural frequency of overall feed screw system Nf [Hz]

$$Nf = \frac{1}{2\pi} \sqrt{K \left(\frac{1}{J1} + \frac{1}{J2} \right)}$$

K : Torsional stiffness of the coupling and feed screw [N · m/rad]
 J1 : Moment of inertia of driving side [kg · m²]
 J2 : Moment of inertia of driven side [kg · m²]

Torsional spring constant of coupling and feed screw K [N · m/rad]

$$\frac{1}{K} = \frac{1}{Kc} + \frac{1}{Kb}$$

Kc : Torsional spring constant of coupling [kg · m²]
 Kb : Torsional spring constant of feed screw [kg · m²]

Driving moment of inertia J1 [kg · m²]

$$J1 = Jm + \frac{Jc}{2}$$

Jm : Moment of inertia of servomotor [kg · m²]
 Jc : Moment of inertia of coupling [kg · m²]

Driven moment of inertia J2 [kg · m²]

$$J2 = Jb + Jt + \frac{Jc}{2}$$

Jb : Moment of inertia of feedscrew [kg · m²]
 Jt : Moment of inertia of table [kg · m²]
 Jc : Moment of inertia of coupling [kg · m²]

Moment of inertia of table Jt [kg · m²]

$$Jt = \frac{M \times P^2}{4\pi^2}$$

M : Mass of table [kg]
 P : Lead of feed screw [m]

Since it is easier for oscillation to occur when the gain margin with natural frequency is 10 dB or lower, it is necessary for the natural frequency to be set high with a therefore higher gain margin at the design stage, or to adjust the natural frequency using the servomotor's electric tuning function (filter function) so as to avoid oscillation.

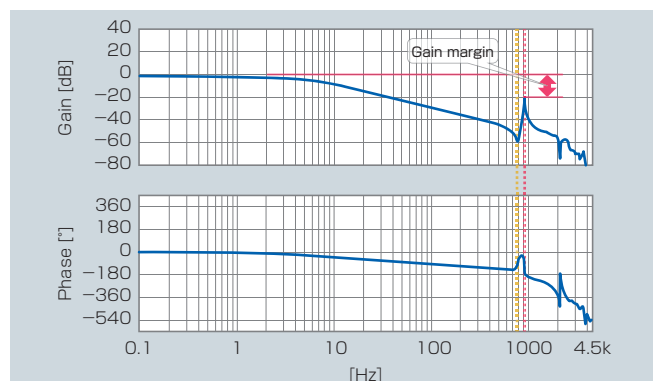

Selection

- (1) Find the torque T_a applied to the coupling using the output capacity, P , of the driver and the usage speed, n .

$$T_a \text{ [N}\cdot\text{m]} = 9550 \times \frac{P \text{ [kW]}}{n \text{ [min}^{-1}\text{]}}$$

- (2) Determine the factor K from the load properties, and find the corrected torque, T_d , applied to the coupling.

$$T_d \text{ [N}\cdot\text{m]} = T_a \text{ [N}\cdot\text{m]} \times K \text{ (see below)}$$

Load properties	Constant	Vibration : Small	Vibration : Medium	Vibration : Large
K	1.0	1.25	1.75	2.25

For servo motor drive, multiply the maximum torque, T_s , by the usage factor $K = 1.2$ to 1.5 .

$$T_d \text{ [N}\cdot\text{m]} = T_s \text{ [N}\cdot\text{m]} \times (1.2 \text{ to } 1.5)$$

- (3) Set the size so that the rated coupling torque, T_n , is higher than the corrected torque, T_d .

$$T_n \text{ [N}\cdot\text{m]} \geq T_d \text{ [N}\cdot\text{m]}$$

- (4) The rated torque of the coupling may be limited by the bore diameter of the coupling. See the Specifications and Standard Bore Diameters tables.
- (5) Check that the mount shaft is no larger than the maximum bore diameter of the coupling.

* Contact MIKI PULLEY for assistance with any device experiencing extreme periodic vibrations.

Easy selection chart

Select a coupling size based on the rated output and the rated/maximum torque of the ordinary servo motor. The torque characteristics of servo motors vary between manufacturers, so check the specifications in the manufacturer catalog before finalizing a coupling size selection.

Servo motor specifications					Corresponding coupling specifications				
Rated output [W or kW]	Rated rotation speed [min ⁻¹]	Rated torque [N·m]	Max. torque [N·m]	Shaft dia. [mm]	Single element type	Double element type	Rated torque [N·m]	Max. bore dia. [mm]	Outer dia. [mm]
3W	3000 ~ 6000	0.0096	0.029	4	SFC-002SA2	SFC-002DA2	0.25	5	12
5W	3000 ~ 6000	0.016	0.048	5	SFC-002SA2	SFC-002DA2	0.25	5	12
10W	3000 ~ 6000	0.032	0.096	6	SFC-005SA2	SFC-005DA2	0.6	6	16
15W	3000 ~ 6000	0.047	0.143	4	SFC-002SA2	SFC-002DA2	0.25	5	12
20W	3000 ~ 6000	0.0638	0.191	6	SFC-005SA2	SFC-005DA2	0.6	6	16
30W	3000 ~ 6000	0.098	0.322	8	SFC-010SA2	SFC-010DA2	1	8	19
50W	3000 ~ 6000	0.16	0.64	8	SFC-010SA2	SFC-010DA2	1	8	19
100W	3000 ~ 6000	0.32	1.28	8	SFC-020SA2	SFC-020DA2	2	11	26
150W	3000 ~ 6000	0.477	1.67	8	SFC-025SA2	SFC-025DA2	4	14	29
200W	3000 ~ 6000	0.64	2.23	14	SFC-025SA2	SFC-025DA2	4	14	29
300W	3000 ~ 6000	0.95	3.72	14	SFC-030SA2	SFC-030DA2	5	16	34
400W	3000 ~ 6000	1.3	5	14	SFC-035SA2	SFC-035DA2	10	19	39
450W	1500	2.86	8.92	19	SFC-040SA2	SFC-040DA2	12	24	44
500W	2000	2.4	7.2	24	SFC-040SA2	SFC-040DA2	12	24	44
600W	3000 ~ 6000	1.91	5.73	19	SFC-035SA2	SFC-035DA2	10	19	39
750W	3000 ~ 6000	2.387	9	19	SFC-040SA2	SFC-040DA2	12	24	44
750W	2000	3.6	10.7	22	SFC-050SA2	SFC-050DA2	25	30	56
850W	1500	5.39	13.8	19	SFC-050SA2	SFC-050DA2	25	30	56
1kW	3000 ~ 6000	3.18	12.5	24	SFC-050SA2	SFC-050DA2	25	30	56
1kW	2000	5	16.6	24	SFC-050SA2	SFC-050DA2	25	30	56
1.5kW	2000	7.5	21.6	35	SFC-060SA2	SFC-060DA2	60	35	68
2kW	3000 ~ 6000	6.8	21	24	SFC-055SA2	SFC-055DA2	40	30	63
2kW	2000	9.54	31	35	SFC-060SA2	SFC-060DA2	60	35	68
2.2kW	2000	10.5	36.7	28	SFC-060SA2	SFC-060DA2	60	35	68
2.5kW	3000 ~ 6000	12	46	24	SFC-060SA2	SFC-060DA2	60	35	68
3kW	3000 ~ 6000	12	35	28	SFC-060SA2	SFC-060DA2	60	35	68
3kW	2000	14.3	42.9	35	SFC-060SA2	SFC-060DA2	60	35	68
3.5kW	3000 ~ 6000	11.1	33.4	28	SFC-060SA2	SFC-060DA2	60	35	68
3.5kW	2000	17	55	35	SFC-080SA2	SFC-080DA2	100	40	82
4kW	3000 ~ 6000	22	39.2	28	SFC-060SA2	SFC-060DA2	60	35	68
4kW	2000	19.1	66.9	35	SFC-080SA2	SFC-080DA2	100	40	82
4.5kW	1500	28.5	105	35	SFC-090SA2	SFC-090DA2	180	45	94
5kW	3000 ~ 6000	15.9	47.6	28	SFC-080SA2	SFC-080DA2	100	40	82
5kW	2000	23.9	71.6	35	SFC-080SA2	SFC-080DA2	100	40	82
6kW	2000	38	130	35	SFC-090SA2	SFC-090DA2	180	45	94
7kW	1500	44.6	134	42	SFC-090SA2	SFC-090DA2	180	45	94
7.5kW	1500	48	139	42	SFC-100SA2	SFC-100DA2	250	45	104
9kW	3000 ~ 6000	28.6	85	35	SFC-090SA2	SFC-090DA2	180	45	94
11kW	2000	52.5	158	42	SFC-100SA2	SFC-100DA2	250	45	104

World Wide Network



PARTNERS					
■ CENTA ANTRIEBE KIRSCHHEY GmbH		■ KENDRION INTORQ GmbH & Co. KG		■ MASCHINENFABRIK MOENNINGHOFF GmbH & CO KG	
■ SCHMIDT-KUPPLUNG GmbH		■ MOTOVARIO S. p. A.		■ CENTA TRANSMISSIONS FAR EAST PTE., LTD.	
■ ETP TRANSMISSION AB.		■ BAMATEC AG		■ ROSTA AG	
■ CENTA CORPORATION		■ HELICAL PRODUCTS COMPANY, INC.		■ LOVEJOY, INC.	

GROUP COMPANIES					
■ MIKI PULLEY (TIANJIN) CO., LTD.		■ MIKI PULLEY (TIANJIN) CO., LTD. SHANGHAI BRANCH		■ ZERO-MAX A/S	
■ VERBINDUNGS-, MESS- UND ANTRIEBSTECHNIK GmbH		■ MIKI PULLEY (HONG KONG) CO., LTD.		■ MIKI PULLEY (INDIA) PVT. LTD.	
■ MIKI PULLEY (KOREA) CO., LTD.		■ MIKI PULLEY (EUROPE) AG		■ MIKI PULLEY (TAIWAN) CO., LTD.	
■ MIKI PULLEY (THAI) CO., LTD.		■ ZERO-MAX, INC.			

DISTRIBUTORS					
■ NAISMITH ENGINEERING & MANUFACTURING CO. PTY. LTD.		■ R. R. FISHER & CO., LTD.		■ HA-CO GmbH	
■ KAISHIN INDUSTRIA E COMERCIO LTDA.		■ NANJING ANSEN M & E EQUIPMENT CO., LTD.		■ SHANGHAI HUITONG AUTOMATIC TECHNOLOGY DEVELOPMENT CO., LTD.	
■ TIANJIN ACE PILLAR CO., LTD.		■ COROLL s.r.o.		■ PRUD' HOMME TRANSMISSIONS	
■ ON GEAR E & M PRODUCTS LTD.		■ RK INDUSTRIAL AUTOMATION PRODUCTS.		■ PHEONIX ENGINEERING	
■ NUTRON SYSTEM		■ SVP TECHNO ENGINEERS PVT. LTD.,		■ PD. CENTRAL TEHNIK	
■ PT. HIMALAYA EVEREST JAYA.		■ DOR DRIVE SYSTEM JAYA.		■ BIANCHI INDUSTRIAL S. p. A. A SOCIO UNICO	
■ SING HUAT HARDWARE & MACHINERY (M) SDN BHD		■ AMMERTECH B. V.		■ R. R. FISHER & CO., LTD.	
■ ELECTRO DRIVES AS		■ LEELENG COMMERCIAL, INC.		■ ADMECH	
■ RF PORTUGAL - ROLAMENTOS E COMPONENTES, LDA.		■ PARCON FREI WALD		■ ELSHIN INTERNATIONAL PTE. LTD.	
■ SING HUAT HARDWARE & MACHINERY PTE. LTD.		■ RODAMIENTOS FEYC S.A.		■ HAUDENSCHILD AG	
■ ACE PILLAR CO., LTD.		■ NAM SAE INTERNATIONAL TRADING CO., LTD.		■ POLYMAK MUHENDISLIK-AHMET COMAK	
■ ABSSAC LTD.		■ SMS MACHINES & AUTOMATION LTD.			

MIKI PULLEY CO., LTD.

<https://www.mikipulley.co.jp/>

10-41 Imaiminami-cho, Nakahara-ku, Kawasaki-shi, Kanagawa-ken, 211-8577, JAPAN